

# **Neosys Technology Inc.**

**Nuvo-8000**

## **User Manual**

Revision 1.1

# Table of Contents

Table of Contents .....	2
Legal Information .....	4
Contact Information .....	5
Declaration of Conformity .....	5
Copyright Notice .....	6
Safety Precautions .....	7
Service and Maintenance .....	8
ESD Precautions .....	8
About This Manual .....	9

## 1 Introduction

<b>1.1 Product Specifications.....</b>	<b>11</b>
1.1.1 Nuvo-8003 Specifications .....	11
1.1.2 Nuvo-8023 Specifications .....	13
1.1.3 Nuvo-8032 Specifications .....	15
1.1.4 Nuvo-8041 Specifications .....	17
<b>1.2 Nuvo-8003 Dimensions.....</b>	<b>19</b>
1.2.1 Nuvo-8003 I/O Panel View .....	19
1.2.2 Nuvo-8003 Side View .....	20
1.2.3 Nuvo-8003 Bottom View .....	20
<b>1.3 Nuvo-8023/ 8032/ 8041 Dimension.....</b>	<b>21</b>
1.3.1 Nuvo-8023/ 8032/ 8041 I/O Panel View .....	21
1.3.2 Nuvo-8023/ 8032/ 8041 Side View .....	22
1.3.3 Nuvo-8023/ 8032/ 8041 Bottom View .....	22

## 2 Overview

<b>2.1 Nuvo-8000 Packing List .....</b>	<b>23</b>
<b>2.2 Nuvo-8000 Series I/O Panel .....</b>	<b>24</b>
2.2.1 Power Button .....	26
2.2.2 3.5mm Speaker/ Headphone Output Jack .....	27
2.2.3 LED Indicators .....	28
2.2.4 USB3.1 Gen 1 Port .....	29
2.2.5 I210 Gigabit Ethernet Port .....	30
2.2.6 DVI Port .....	31
2.2.7 Reset Button .....	32
2.2.8 USB3.1 Gen 1 Port .....	33
2.2.9 I219 Gigabit Ethernet Port .....	34
2.2.10 COM2 Port .....	35
2.2.11 COM1 Port .....	36
2.2.12 3-Pin Terminal Block for DC Input .....	37
2.2.13 COM3/ 4/ 5 Port .....	38
<b>2.3 Internal I/O Functions.....</b>	<b>39</b>
2.3.1 SODIMM DRAM Slot .....	39
2.3.2 mSATA Slot & Pin Definition.....	40
2.3.3 SATA Ports.....	42
2.3.4 On/ Off Ctrl & Status Output.....	43
2.3.5 Internal USB 2.0 Port.....	45

## 3 System Installation

<b>3.1 Disassembling the System .....</b>	<b>47</b>
<b>3.2 Installing Internal Components.....</b>	<b>50</b>
3.2.1 CPU Installation Procedure.....	50
3.2.2 DDR4 SO-DIMM Installation .....	59
3.2.3 mSATA, Mini-SIM (2FF) Card and Antennae Installation .....	61
3.2.4 HDD/ SSD Installation.....	63

<b>3.3</b>	<b>Installing the System Enclosure .....</b>	<b>65</b>
<b>3.4</b>	<b>Wall-mount Bracket Installation .....</b>	<b>67</b>
<b>3.5</b>	<b>DIN-rail Installation (Optional).....</b>	<b>68</b>
<b>3.6</b>	<b>Powering On the System .....</b>	<b>70</b>
3.6.1	Powering On Using the Power Button.....	70
3.6.2	Powering On Using Wake-on-LAN.....	71
3.6.3	Configure your Windows system.....	73

## **4 System Configuration**

<b>4.1</b>	<b>BIOS Settings .....</b>	<b>74</b>
4.1.1	COM Port Configuration.....	75
4.1.2	COM Port High Speed Mode .....	76
4.1.3	Delay for PEG Initialization .....	77
4.1.4	SATA and mSATA Configuration .....	78
4.1.5	Fan Control Configuration.....	79
4.1.6	Power On After Power Failure Option .....	84
4.1.7	Power & Performance (CPU SKU Power Configuration) .....	85
4.1.8	Wake on LAN Option .....	86
4.1.9	Boot Menu .....	87
4.1.10	Boot Type (Legacy/ UEFI).....	89
4.1.11	Position New Boot Device.....	90
4.1.12	Watchdog Timer for Booting.....	91
4.1.13	Legacy/ UEFI Boot Device.....	92
<b>4.2</b>	<b>AMT Configuration .....</b>	<b>93</b>

## **5 OS Support and Driver Installation**

<b>5.1</b>	<b>Operating System Compatibility .....</b>	<b>95</b>
<b>5.2</b>	<b>Driver Installation .....</b>	<b>96</b>
5.2.1	Install Drivers Automatically .....	96
5.2.2	Install Drivers Manually .....	97
<b>5.3</b>	<b>Driver Installation for Watchdog Timer Control.....</b>	<b>98</b>

## **Appendix A Using WDT & DIO**

<b>WDT and DIO Library Installation .....</b>	<b>100</b>
<b>WDT Functions.....</b>	<b>102</b>
InitWDT .....	102
SetWDT .....	102
StartWDT .....	103
ResetWDT .....	103
StopWDT .....	103

# Legal Information

All Neosys Technology Inc. products shall be subject to the latest Standard Warranty Policy

Neosys Technology Inc. may modify, update or upgrade the software, firmware or any accompanying user documentation without any prior notice. Neosys Technology Inc. will provide access to these new software, firmware or documentation releases from download sections of our website or through our service partners.

Before installing any software, applications or components provided by a third party, customer should ensure that they are compatible and interoperable with Neosys Technology Inc. product by checking in advance with Neosys Technology Inc.. Customer is solely responsible for ensuring the compatibility and interoperability of the third party's products. Customer is further solely responsible for ensuring its systems, software, and data are adequately backed up as a precaution against possible failures, alternation, or loss.

For questions in regards to hardware/ software compatibility, customers should contact Neosys Technology Inc. sales representative or technical support.

To the extent permitted by applicable laws, Neosys Technology Inc. shall NOT be responsible for any interoperability or compatibility issues that may arise when (1) products, software, or options not certified and supported; (2) configurations not certified and supported are used; (3) parts intended for one system is installed in another system of different make or model.

# Contact Information

---

**Headquarters**  
**(Taipei, Taiwan)**

**Neosys Technology Inc.**  
15F, No.868-3, Zhongzheng Rd., Zhonghe Dist., New Taipei City, 23586, Taiwan  
Tel: +886-2-2223-6182 Fax: +886-2-2223-6183 [Email](#), [Website](#)

---

**Americas**  
**(Illinois, USA)**

**Neosys Technology America Inc.**  
3384 Commercial Avenue, Northbrook, IL 60062, USA  
Tel: +1-847-656-3298 [Email](#), [Website](#)

---

**China**

**Neosys Technology (China) Ltd.**  
Room 612, Building 32, Guiping Road 680, Shanghai  
Tel: +86-2161155366 [Email](#), [Website](#)

---

# Declaration of Conformity

**FCC**

This equipment has been tested and found to comply with the limits for a Class A digital device, pursuant to part 15 of the FCC Rules. These limits are designed to provide reasonable protection against harmful interference when the equipment is operated in a commercial environment. This equipment generates, uses, and can radiate radio frequency energy and, if not installed and used in accordance with the instruction manual, may cause harmful interference to radio communications. Operation of this equipment in a residential area is likely to cause harmful interference in which case the user will be required to correct the interference at own expense.

---

**CE**

The product(s) described in this manual complies with all applicable European Union (CE) directives if it has a CE marking. For computer systems to remain CE compliant, only CE-compliant parts may be used. Maintaining CE compliance also requires proper cable and cabling techniques.

# Copyright Notice

All rights reserved. This publication may not be reproduced, transmitted, transcribed, stored in a retrieval system, or translated into any language or computer language, in any form or by any means, electronic, mechanical, magnetic, optical, chemical, manual or otherwise, without the prior written consent of Neosys Technology, Inc.

---

## **Disclaimer**

This manual is intended to be used as an informative guide only and is subject to change without prior notice. It does not represent commitment from Neosys Technology Inc. Neosys Technology Inc. shall not be liable for any direct, indirect, special, incidental, or consequential damages arising from the use of the product or documentation, nor for any infringement on third party rights.

---

## **Patents and Trademarks**

Neosys, the Neosys logo, Expansion Cassette, MezIO™ are registered patents and trademarks of Neosys Technology, Inc.

Windows is a registered trademark of Microsoft Corporation.

Intel®, Core™ are registered trademarks of Intel Corporation

NVIDIA® is a registered trademark of NVIDIA Corporation

All other names, brands, products or services are trademarks or registered trademarks of their respective owners.

# Safety Precautions

- Read these instructions carefully before you install, operate, or transport the system.
- Install the system or DIN rail associated with, at a sturdy location
- Install the power socket outlet near the system where it is easily accessible
- Secure each system module(s) using its retaining screws
- Place power cords and other connection cables away from foot traffic. Do not place items over power cords and make sure they do not rest against data cables
- Shutdown, disconnect all cables from the system and ground yourself before touching internal modules
- Ensure that the correct power range is being used before powering the device
- Should a module fail, arrange for a replacement as soon as possible to minimize down-time
- If the system is not going to be used for a long time, disconnect it from mains (power socket) to avoid transient over-voltage

# Service and Maintenance

- ONLY qualified personnel should service the system
- Shutdown the system, disconnect the power cord and all other connections before servicing the system
- When replacing/ installing additional components (expansion card, memory module, etc.), insert them as gently as possible while assuring proper connector engagement

# ESD Precautions

- Handle add-on module, motherboard by their retention screws or the module's frame/ heat sink. Avoid touching the PCB circuit board or add-on module connector pins
- Use a grounded wrist strap and an anti-static work pad to discharge static electricity when installing or maintaining the system
- Avoid dust, debris, carpets, plastic, vinyl and styrofoam in your work area.
- Do not remove any module or component from its anti-static bag before installation



# About This Manual

This manual introduces Neosys Nuvo-8000 Series featuring Intel® 9<sup>th</sup>/ 8<sup>th</sup> Gen Core™ i hexa/ octa core 35W LGA1151 processors with up to 5 slot expandability. The system is capable of supporting one 125W NVIDIA® graphics card for modern AI applications.

The guide also demonstrates the system's installation procedures.

## Revision History

Version	Date	Description
1.0	Feb. 2021	Initial release
1.1	Aug. 2021	Updated Nuvo-8023 PCIe lane specifications

# 1 Introduction

Nuvo-8000 series systems are cost-effective box-PCs with up to 5 expansion slots that can perfectly replace your bulky rack-mount or wall-mount IPC systems. Leveraging Intel® 9th/ 8th-Gen Core™ i desktop processor with H310 chipset, it delivers the same computing power as traditional IPCs but in a much more compact footprint with a budgetary price.



There are four models in the Nuvo-8000 series with various expansion configurations. Customers can choose from a compact 3-slot PCIe system to a 5-slot system with up to three PCIe slots or up to four PCI slots, that best suit their industrial automation or machine vision application needs. It features front-accessible I/Os including two GbE, four USB 3.1 Gen1 and five COM ports that make it easier to access when it is rack-mounted or placed inside a cabinet. Storage wise, Nuvo-8000 series systems have two 2.5" SATA SSD/ HDD and one mSATA socket to support various storage devices. The system can also support a 125W NVIDIA® GPU to offer TFLOPS computing power for modern deep-learning applications.

Nuvo-8000 series systems are designed with satisfying industrial demands in mind. Retaining traditional IPC expansion capabilities and fulfilling diverse application requirements in an extremely compact form-factor with industrial-grade reliability.

## 1.1 Product Specifications

### 1.1.1 Nuvo-8003 Specifications

<b>System Core</b>	
Processor	Supporting Intel® 9th/ 8th-Gen Core™ CPU (LGA1151 socket) - Intel® Core™ i7-8700*/ i7-8700T/ i7-9700TE - Intel® Core™ i5-8500*/ i5-8500T/ i5-9500TE - Intel® Core™ i3-8100*/ i3-8100T/ i3-9100TE - Intel® Pentium® G5400T (4M Cache, 3.1GHz, 35W TDP) - Intel® Celeron® G4900T (2M Cache, 2.9GHz, 35W TDP)
Chipset	Intel® H310 platform controller hub
Graphics	Integrated Intel® UHD Graphics 630, or independent 120W GPU via x16 PEG port
Memory	Up to 32 GB DDR4 2666 SDRAM (one SODIMM slot)
<b>I/O Interface</b>	
Ethernet	1x Gigabit Ethernet port by Intel® I219-LM 1x Gigabit Ethernet port by Intel® I210-IT
Native Video	2x DVI-D connector, supporting 1920 x 1200 resolution
Serial Port	1x software-programmable RS-232/ 422/ 485 ports (COM1) 1x software-programmable RS-422/ 485 ports (COM2) 3x 3-wire RS-232 ports (COM3/ COM4/ COM5)
USB	4x USB 3.1 Gen1 (5 Gbps) ports 2x USB 2.0 ports (internal for dongle use)
Audio	1x 3.5mm jack for mic-in and speaker-out
<b>Storage Interface</b>	
SATA	2x internal SATA ports for 2.5" HDD/ SSD installation
mSATA	2x full-size mSATA port
<b>Expansion Bus</b>	
PCI Express	1x PCIe x16 slot@Gen3, 16-lanes 1x PCIe x8 slot@Gen2, 4-lanes 1x PCIe x4 slot@Gen2, 1-lanes
PCI	N/A
mSATA	1x full-size mSATA socket (mux with USB 2.0 signals)
<b>Power Supply</b>	
DC Input	1x 3-pin pluggable terminal block for 8-35V DC input
Max. power	68.2W @ 24V (i7-9700TE @ 35W TDP)

consumption	
<b>Mechanical</b>	
Dimension	154 mm (W) x 236 mm (D) x 174 mm (H)
Weight	3 Kg
Mounting	Wall-mounting(Standard) DIN-Rail(optional) Rack-mount (optional)
<b>Environmental</b>	
Operating temperature	-25°C ~ 60°C
Storage temperature	-40°C ~85°C
Humidity	10%~90% , non-condensing
Vibration	Operating, MIL-STD-810G, Method 514.6, Category 4
Shock	Operating, MIL-STD-810G, Method 516.6, Procedure I, functional shock=20g
EMC	CE/ FCC Class A, according to EN 55024 & EN 55032

### 1.1.2 Nuvo-8023 Specifications

<b>System Core</b>	
Processor	Supporting Intel® 9th/ 8th-Gen Core™ CPU (LGA1151 socket) - Intel® Core™ i7-8700*/ i7-8700T/ i7-9700TE - Intel® Core™ i5-8500*/ i5-8500T/ i5-9500TE - Intel® Core™ i3-8100*/ i3-8100T/ i3-9100TE - Intel® Pentium® G5400T (4M Cache, 3.1GHz, 35W TDP) - Intel® Celeron® G4900T (2M Cache, 2.9GHz, 35W TDP)
Chipset	Intel® H310 platform controller hub
Graphics	Integrated Intel® UHD Graphics 630, or independent 120W GPU via x16 PEG port
Memory	Up to 32 GB DDR4 2666 SDRAM (one SODIMM slot)
<b>I/O Interface</b>	
Ethernet	1x Gigabit Ethernet port by Intel® I219-LM 1x Gigabit Ethernet port by Intel® I210-IT
Native Video	2x DVI-D connector, supporting 1920 x 1200 resolution
Serial Port	1x software-programmable RS-232/ 422/ 485 ports (COM1) 1x software-programmable RS-422/ 485 ports (COM2) 3x 3-wire RS-232 ports (COM3/ COM4/ COM5)
USB	4x USB 3.1 Gen1 (5 Gbps) ports 2x USB 2.0 ports (internal for dongle use)
Audio	1x 3.5mm jack for mic-in and speaker-out
<b>Storage Interface</b>	
SATA	2x internal SATA ports for 2.5" HDD/ SSD installation
mSATA	2x full-size mSATA port
<b>Expansion Bus</b>	
PCI Express	1x PCIe x16 slot@Gen3, 16-lanes 1x PCIe x4 slots@Gen2, 2-lanes 1x PCIe x4 slots@Gen2, 1-lanes
PCI	2x 33MHz/ 32-bit 5V PCI slots
mSATA	1x full-size mSATA socket (mux with USB 2.0 signals)
<b>Power Supply</b>	
DC Input	1x 3-pin pluggable terminal block for 8-35V DC input
Max. power consumption	70.8W @ 24V (i7-9700TE @ 35W)
<b>Mechanical</b>	

Dimension	185 mm (W) x 236 mm (D) x 174 mm (H)
Weight	3.6 Kg
Mounting	Wall-mounting(Standard) DIN-Rail(optional) Rack-mount (optional)
<b>Environmental</b>	
Operating temperature	-25°C ~ 60°C
Storage temperature	-40°C ~85°C
Humidity	10%~90% , non-condensing
Vibration	Operating, MIL-STD-810G, Method 514.6, Category 4
Shock	Operating, MIL-STD-810G, Method 516.6, Procedure I, functional shock=20g
EMC	CE/ FCC Class A, according to EN 55024 & EN 55032

### 1.1.3 Nuvo-8032 Specifications

<b>System Core</b>	
Processor	Supporting Intel® 9th/ 8th-Gen Core™ CPU (LGA1151 socket) - Intel® Core™ i7-8700*/ i7-8700T/ i7-9700TE - Intel® Core™ i5-8500*/ i5-8500T/ i5-9500TE - Intel® Core™ i3-8100*/ i3-8100T/ i3-9100TE - Intel® Pentium® G5400T (4M Cache, 3.1GHz, 35W TDP) - Intel® Celeron® G4900T (2M Cache, 2.9GHz, 35W TDP)
Chipset	Intel® H310 platform controller hub
Graphics	Integrated Intel® UHD Graphics 630, or independent 120W GPU via x16 PEG port
Memory	Up to 32 GB DDR4 2666 SDRAM (one SODIMM slot)
<b>I/O Interface</b>	
Ethernet	1x Gigabit Ethernet port by Intel® I219-LM 1x Gigabit Ethernet port by Intel® I210-IT
Native Video	2x DVI-D connector, supporting 1920 x 1200 resolution
Serial Port	1x software-programmable RS-232/ 422/ 485 ports (COM1) 1x software-programmable RS-422/ 485 ports (COM2) 3x 3-wire RS-232 ports (COM3/ COM4/ COM5)
USB	4x USB 3.1 Gen1 (5 Gbps) ports 2x USB 2.0 ports (internal for dongle use)
Audio	1x 3.5mm jack for mic-in and speaker-out
<b>Storage Interface</b>	
SATA	2x internal SATA ports for 2.5" HDD/ SSD installation
mSATA	2x full-size mSATA port
<b>Expansion Bus</b>	
PCI Express	1x PCIe x16 slot@Gen3, 8-lanes 1x PCIe x8 slots@Gen2, 4-lanes
PCI	3x 33MHz/ 32-bit 5V PCI slots
mSATA	1x full-size mSATA socket (mux with USB 2.0 signals)
<b>Power Supply</b>	
DC Input	1x 3-pin pluggable terminal block for 8-35V DC input
Max. power consumption	70.8W @ 24V (i7-9700TE @ 35W)
<b>Mechanical</b>	
Dimension	185 mm (W) x 236 mm (D) x 174 mm (H)

Weight	3.6 Kg
Mounting	Wall-mounting(Standard) DIN-Rail(optional) Rack-mount (optional)
<b>Environmental</b>	
Operating temperature	-25°C ~ 60°C
Storage temperature	-40°C ~85°C
Humidity	10%~90% , non-condensing
Vibration	Operating, MIL-STD-810G, Method 514.6, Category 4
Shock	Operating, MIL-STD-810G, Method 516.6, Procedure I, functional shock=20g
EMC	CE/ FCC Class A, according to EN 55024 & EN 55032



### 1.1.4 Nuvo-8041 Specifications

<b>System Core</b>	
Processor	Supporting Intel® 9th/ 8th-Gen Core™ CPU (LGA1151 socket) - Intel® Core™ i7-8700*/ i7-8700T/ i7-9700TE - Intel® Core™ i5-8500*/ i5-8500T/ i5-9500TE - Intel® Core™ i3-8100*/ i3-8100T/ i3-9100TE - Intel® Pentium® G5400T (4M Cache, 3.1GHz, 35W TDP) - Intel® Celeron® G4900T (2M Cache, 2.9GHz, 35W TDP)
Chipset	Intel® H310 platform controller hub
Graphics	Integrated Intel® UHD Graphics 630, or independent 120W GPU via x16 PEG port
Memory	Up to 32 GB DDR4 2666 SDRAM (one SODIMM slot)
<b>I/O Interface</b>	
Ethernet	1x Gigabit Ethernet port by Intel® I219-LM 1x Gigabit Ethernet port by Intel® I210-IT
Native Video	2x DVI-D connector, supporting 1920 x 1200 resolution
Serial Port	1x software-programmable RS-232/ 422/ 485 ports (COM1) 1x software-programmable RS-422/ 485 ports (COM2) 3x 3-wire RS-232 ports (COM3/ COM4/ COM5)
USB	4x USB 3.1 Gen1 (5 Gbps) ports 2x USB 2.0 ports (internal for dongle use)
Audio	1x 3.5mm jack for mic-in and speaker-out
<b>Storage Interface</b>	
SATA	2x internal SATA ports for 2.5" HDD/ SSD installation
mSATA	2x full-size mSATA port
<b>Expansion Bus</b>	
PCI Express	1x PCIe x16 slot@Gen3, 8-lanes
PCI	4x 33MHz/ 32-bit 5V PCI slots
mSATA	1x full-size mSATA socket (mux with USB 2.0 signals)
<b>Power Supply</b>	
DC Input	1x 3-pin pluggable terminal block for 8-35V DC input
Max. power consumption	70.8W @ 24V (i7-9700TE @ 35W)
<b>Mechanical</b>	
Dimension	185 mm (W) x 236 mm (D) x 174 mm (H)
Weight	3.6 Kg

Mounting	Wall-mounting(Standard) DIN-Rail(optional) Rack-mount (optional)
<b>Environmental</b>	
Operating temperature	-25°C ~ 60°C
Storage temperature	-40°C ~85°C
Humidity	10%~90% , non-condensing
Vibration	Operating, MIL-STD-810G, Method 514.6, Category 4
Shock	Operating, MIL-STD-810G, Method 516.6, Procedure I, functional shock=20g
EMC	CE/ FCC Class A, according to EN 55024 & EN 55032

## 1.2 Nuvo-8003 Dimensions

 **NOTE**

*All measurements are in millimeters (mm).*

### 1.2.1 Nuvo-8003 I/O Panel View

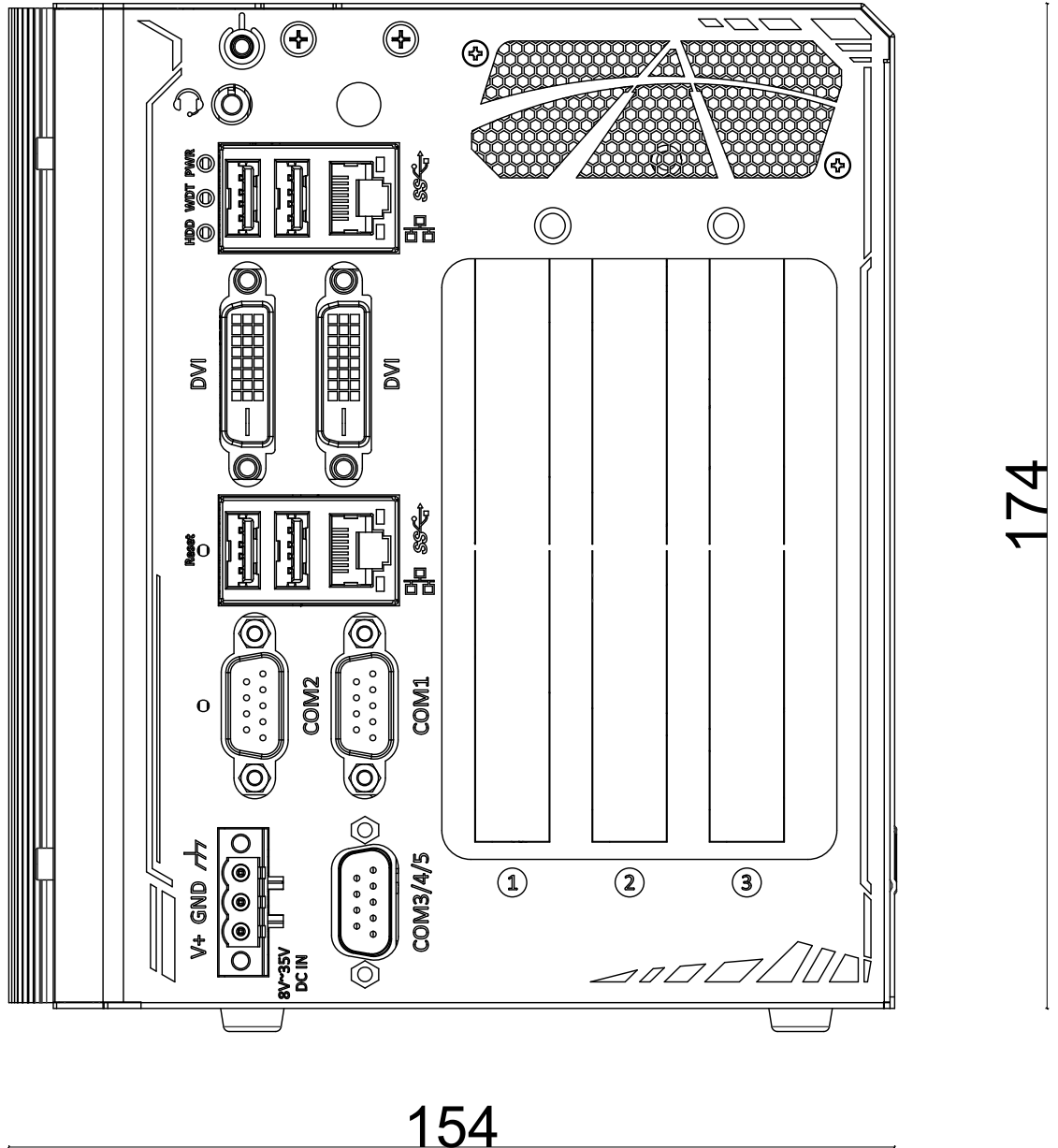

### 1.2.2 Nuvo-8003 Side View

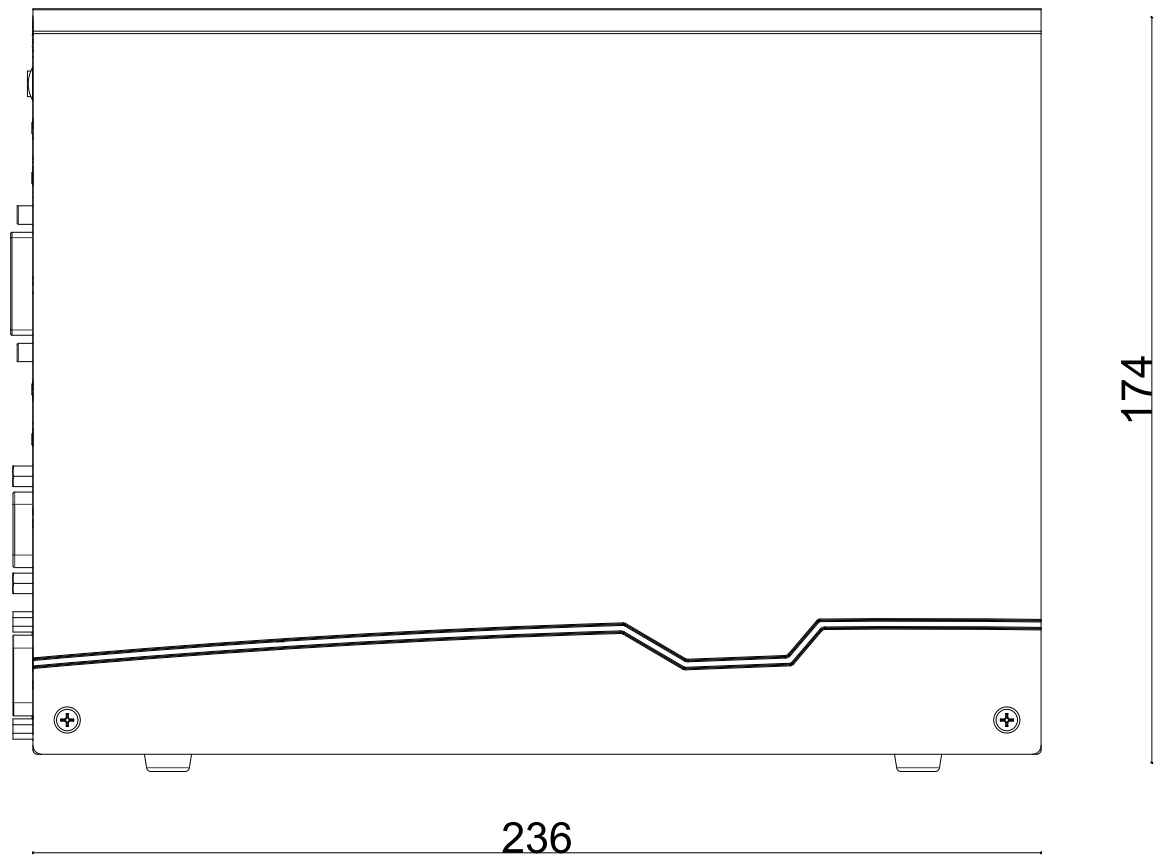

### 1.2.3 Nuvo-8003 Bottom View

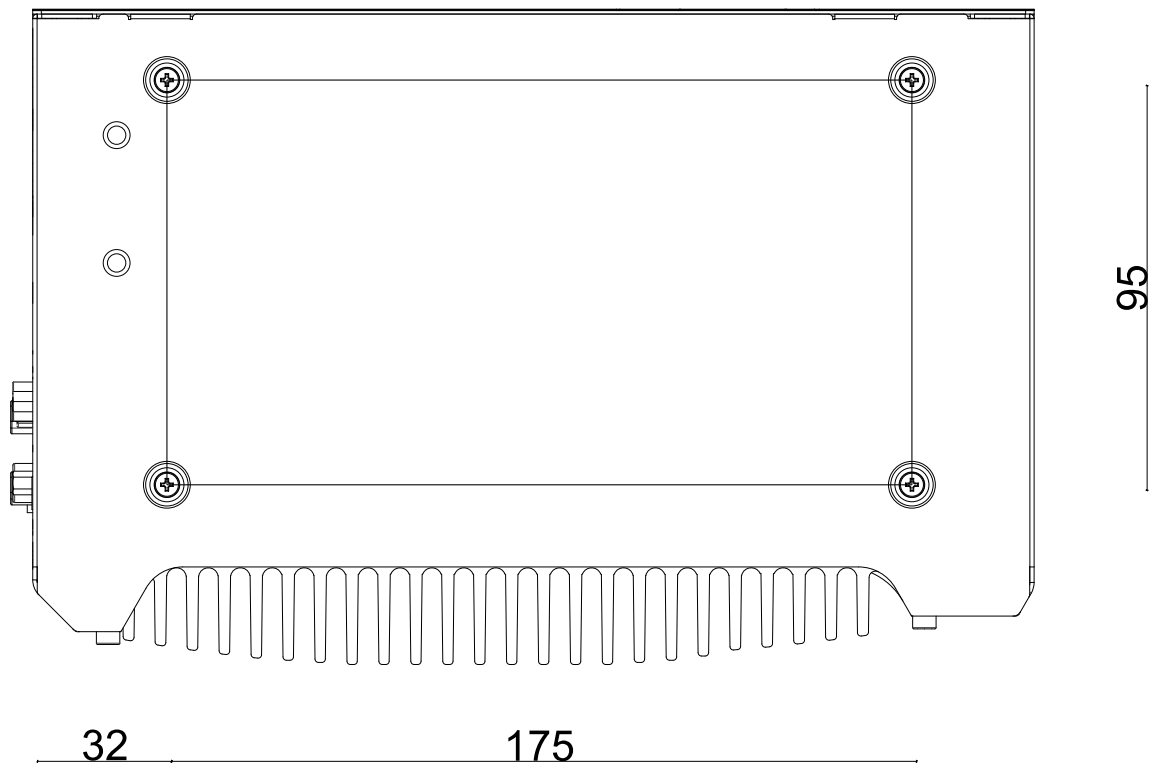

### 1.3 Nuvo-8023/ 8032/ 8041 Dimension

 **NOTE**

*Nuvo-8023/ 8032/ 8041 systems share the same external dimensions.*

*All measurements are in millimeters (mm).*

#### 1.3.1 Nuvo-8023/ 8032/ 8041 I/O Panel View

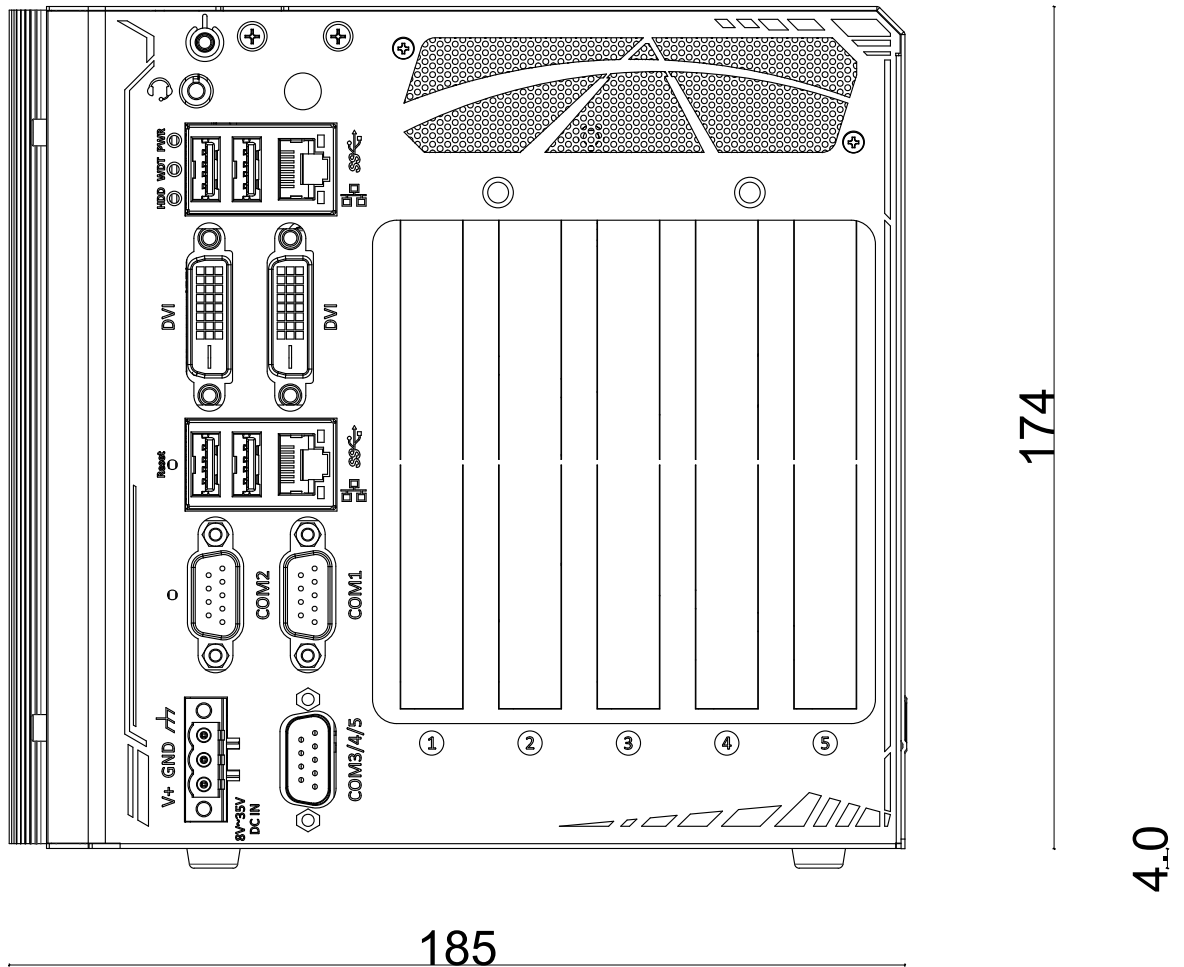

**1.3.2 Nuvo-8023/ 8032/ 8041 Side View**

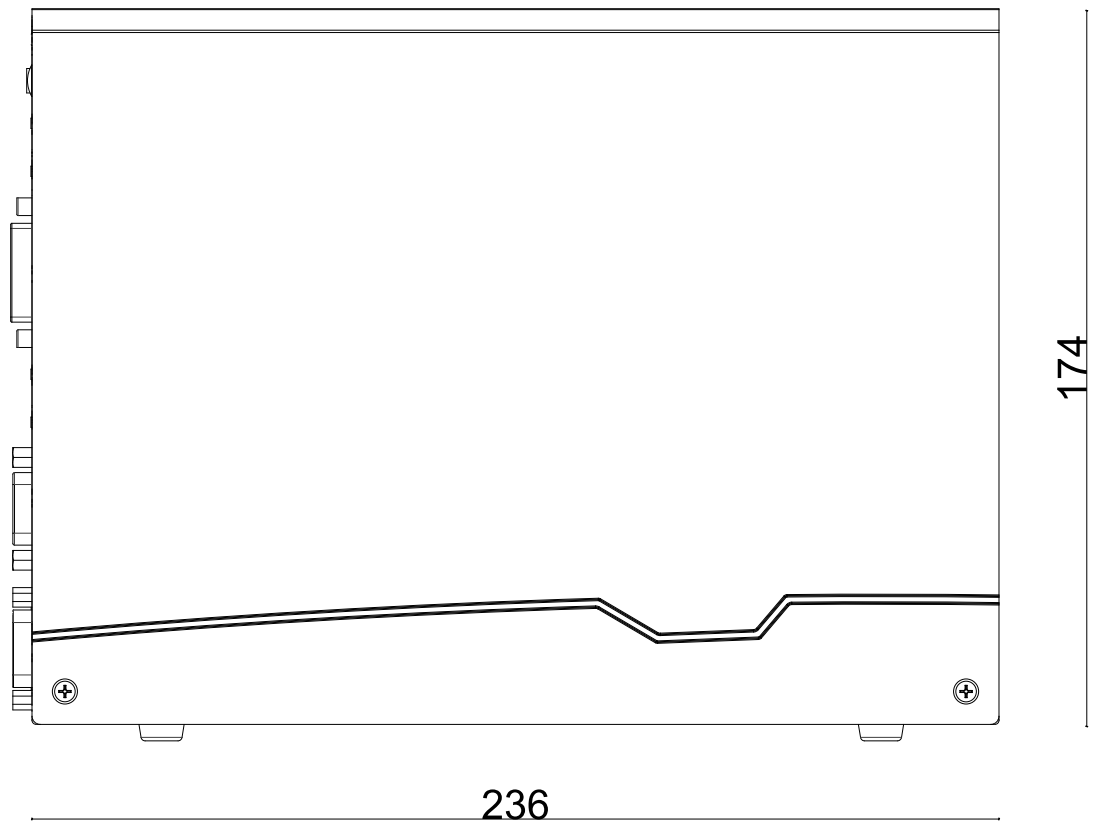

**1.3.3 Nuvo-8023/ 8032/ 8041 Bottom View**

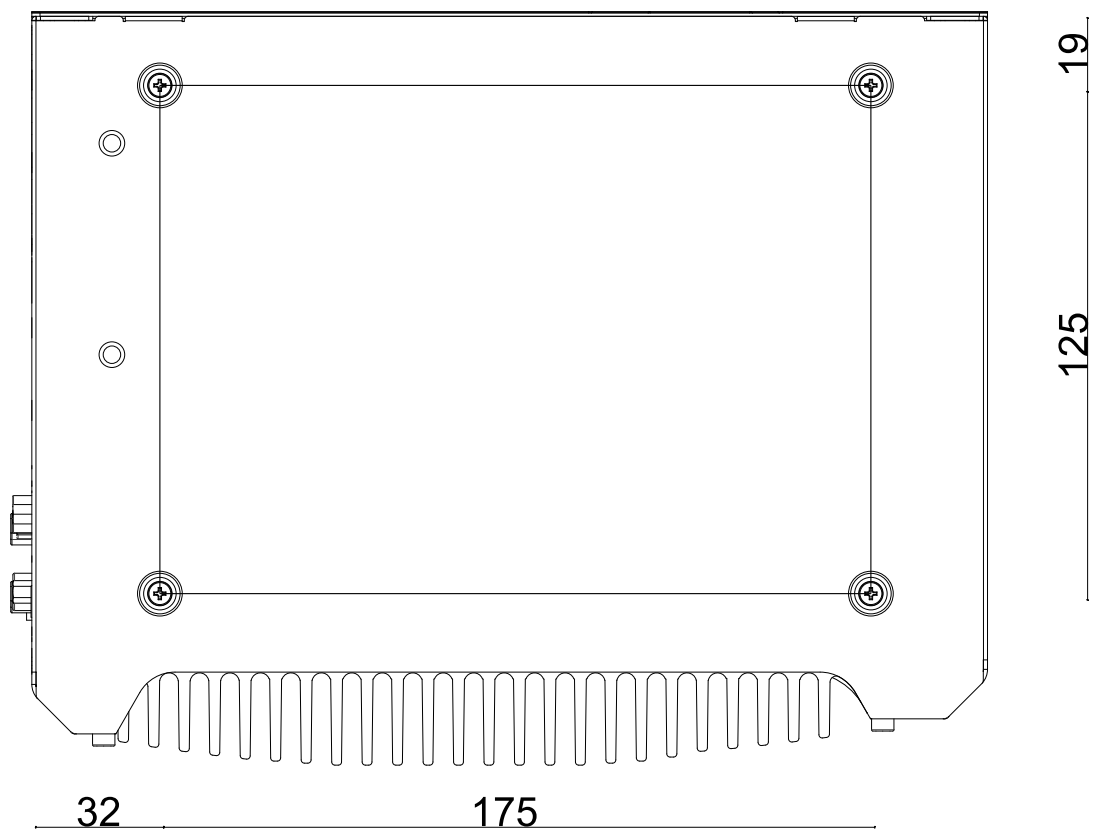

## 2 Overview

Upon receiving and unpacking your Nuvo-8000 system, please check immediately if the package contains all the items listed in the following table. If any item(s) are missing or damaged, please contact your local dealer or Neosys Technology.

### 2.1 Nuvo-8000 Packing List

System Pack	Nuvo-8000 series	Qty
1	Nuvo-8000 series system (If you ordered CPU/ RAM/ HDD, please verify these items)	1
2	Accessory box, which contains <ul style="list-style-type: none"> <li>● CPU bracket</li> <li>● Neosys drivers &amp; utilities DVD</li> <li>● Wall-mount bracket</li> <li>● Foot pad</li> <li>● 3-pin power terminal block</li> <li>● Screw pack</li> </ul>	1 1 2 4 1 1

## 2.2 Nuvo-8000 Series I/O Panel



### NOTE

*Nuvo-8000 series systems share the same I/O connections and differ only in their number of PCIe and PCI slots. For demonstration purposes, an illustration matching Nuvo-8023/ 8032/ 8041 will be used in the following sections.*

### Nuvo-8000 series I/O Panel

The Nuvo-8000 I/O panel features Gen1 USB3.0, DVI, Ethernet and COM ports.

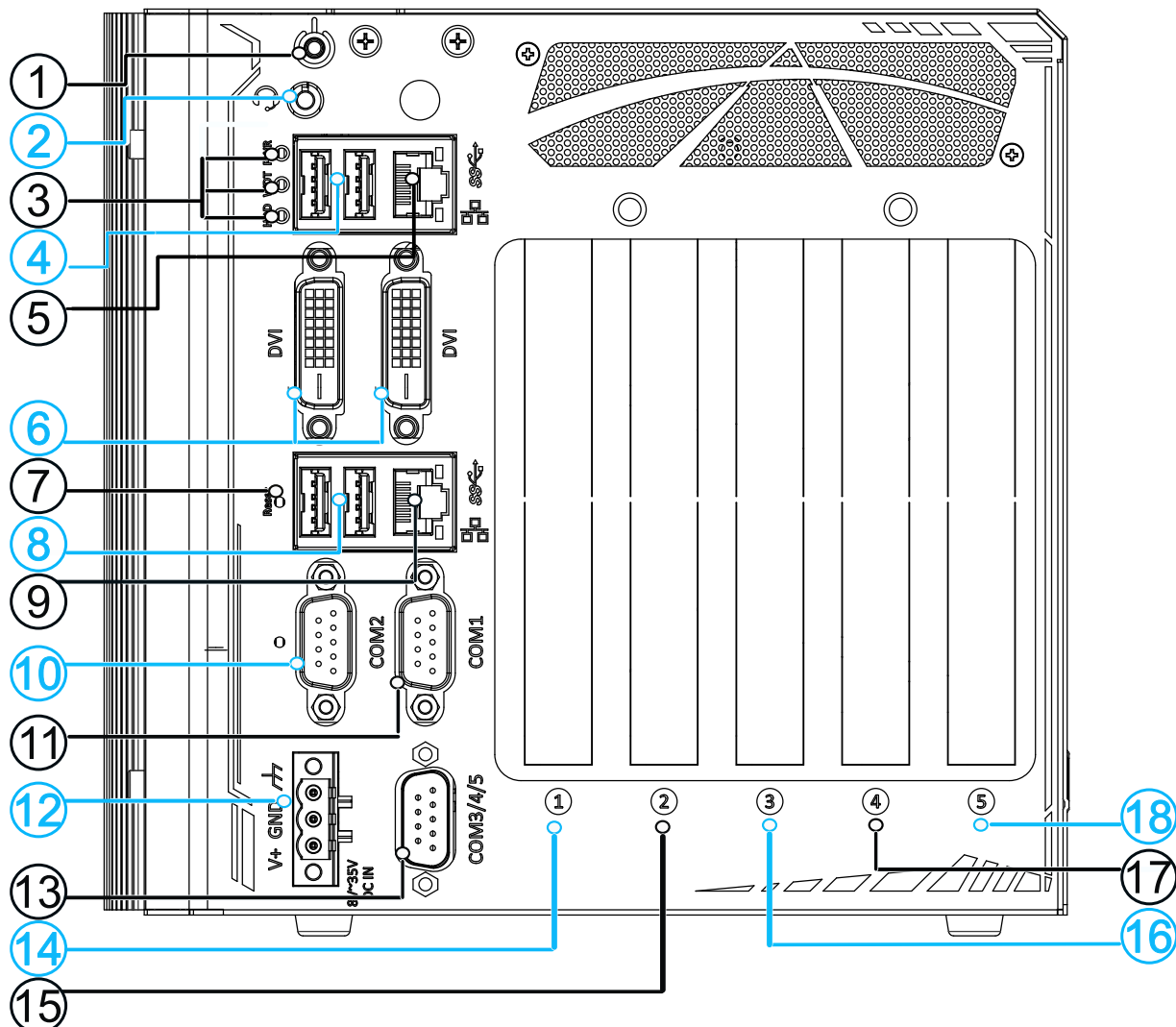

No.	Item	Description
1	<a href="#">Power button</a>	Use this button to turn on or shutdown the system.
2	<a href="#">4-Pole 3.5mm headphone/</a>	The 4-pole 3.5mm jack accepts microphone voice input and headphone speaker sound output.



	<a href="#">microphone jack</a>	
3	<a href="#">LED indicator</a>	From top to bottom, the LEDs are PWR (system power), WDT (watchdog timer), HDD (hard disk drive).
4	<a href="#">USB 3.1 Gen1 port</a>	USB3.1 Gen 1 offers up to 5Gbps of data-throughput performance
5	<a href="#">Ethernet port</a>	Gigabit Ethernet port by Intel® I210-IT
6	<a href="#">DVI port</a>	DVI-D output supports resolution up to 1920x1200@60Hz and is compatible with other digital connections via an adapter.
7	<a href="#">Reset button</a>	Use this button to manual reset the system.
8	<a href="#">USB 3.1 Gen1 port</a>	USB3.1 Gen 1 offers up to 5Gbps of data-throughput performance
9	<a href="#">Ethernet port</a>	Gigabit Ethernet port by Intel® I219-LM
10	COM 2	COM 2 port is a software-selectable RS-422/ 485 port. The operation mode can be set in the BIOS.
11	COM 1	COM 1 port is a software-selectable RS-232/ 422/ 485 port. The operation mode can be set in BIOS.
12	<a href="#">3-pin terminal block</a>	The system accepts 8-35V DC power input.
13	<a href="#">COM port 3/ 4/ 5</a>	COM3, COM4 and COM5 are 3-wire RS-232 ports that share a single DB9 connector.
14	PCIe expansion slot	PCIe x16 Gen3 16-lanes
15	Expansion slot	Nuvo-8003: PCIe x8 Gen2 4-lanes Nuvo-8023: PCIe x4 Gen2 2-lanes Nuvo-8032: PCIe x8 Gen2 4-lanes Nuvo-8041: 33MHz/ 32-bit 5V PCI slot
16	Expansion slot	Nuvo-8003: PCIe x4 Gen2 1-lane Nuvo-8023: PCIe x4 Gen2 1-lane Nuvo-8032: 33MHz/ 32-bit 5V PCI slot Nuvo-8041: 33MHz/ 32-bit 5V PCI slot
17	Expansion slot	
18	(Nuvo-8023/ 8032/ 8041 only)	33MHz/ 32-bit 5V PCI slot

## 2.2.1 Power Button

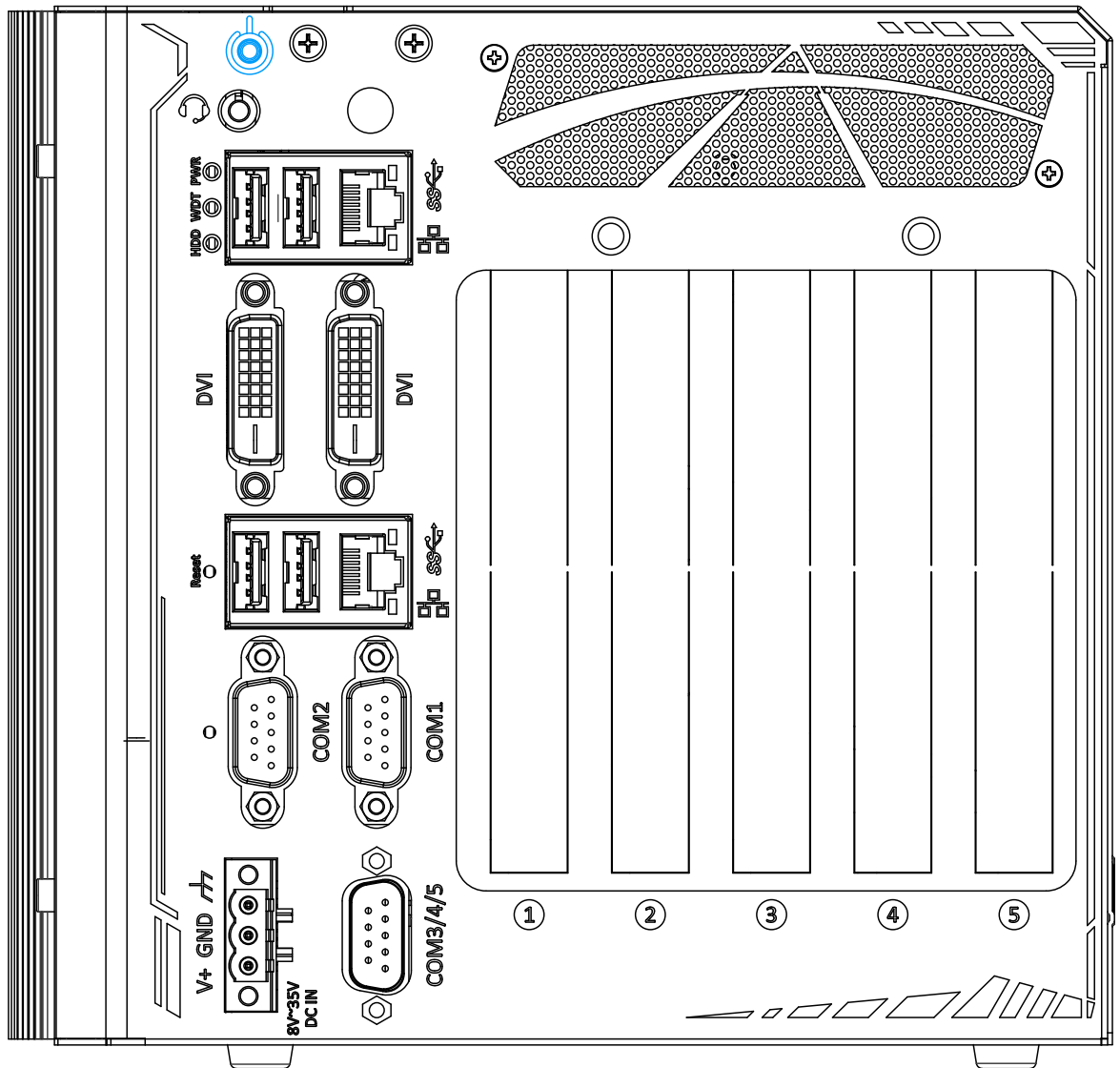

The power button is a non-latched switch for ATX mode on/off operation. To turn on the system, press the power button and the PWR LED should light-up green. To turn off the system, issuing a shutdown command in OS is preferred, or you can simply press the power button. To force shutdown when the system freezes, press and hold the power button for 5 seconds. Please note that there is a 5-second interval between on/off operations (i.e. once the system is turned off, there is a 5-second wait before you can power-on the system).

### 2.2.2 3.5mm Speaker/ Headphone Output Jack

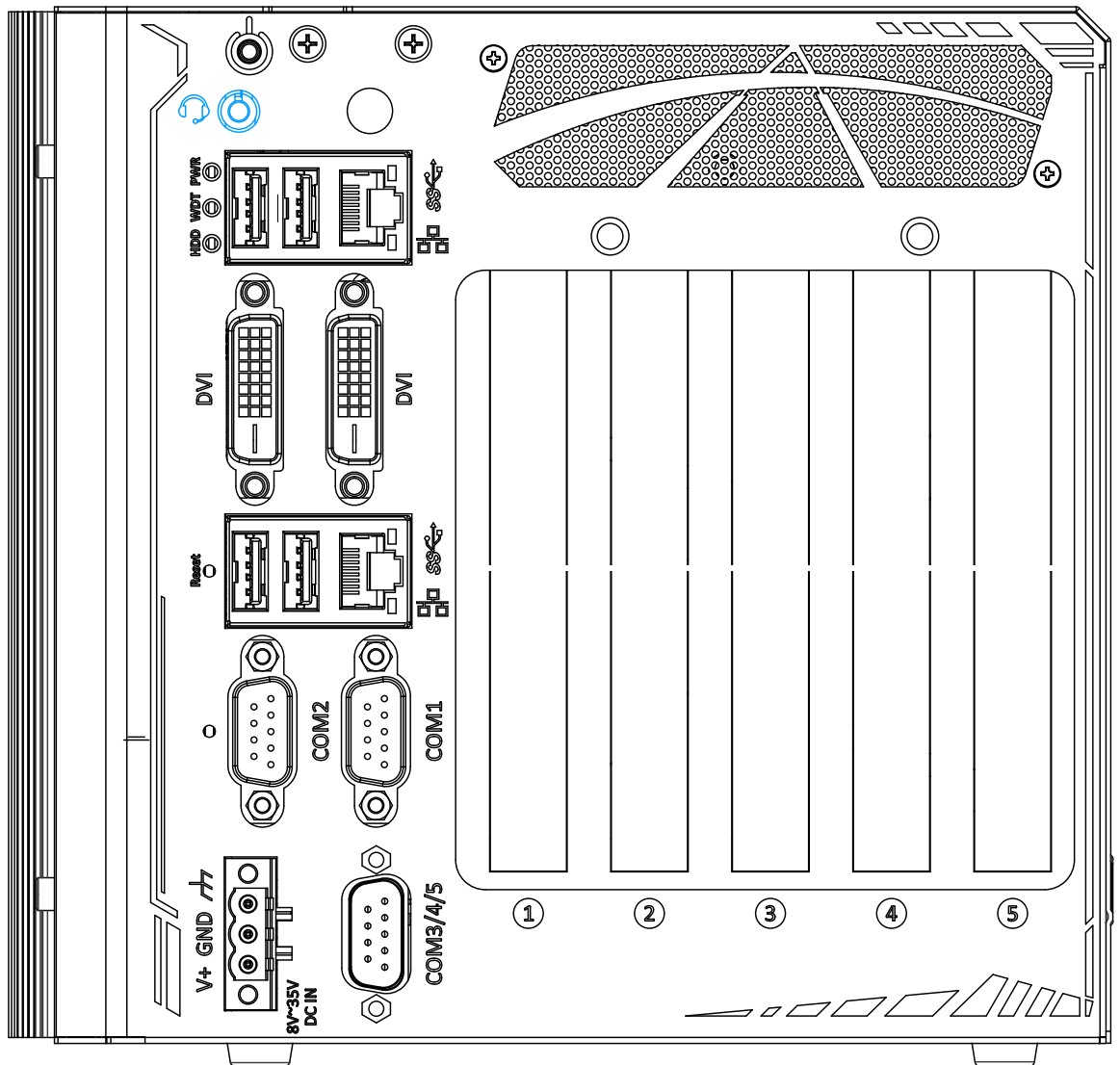

The system audio function uses high definition audio Realtek ALC262 codec. There is a female 4-pole  audio jack for headphone (speaker) output and microphone input . To utilize the audio function in Windows, you need to install corresponding drivers for both Intel® C246 chipset and audio device drivers.

### 2.2.3 LED Indicators

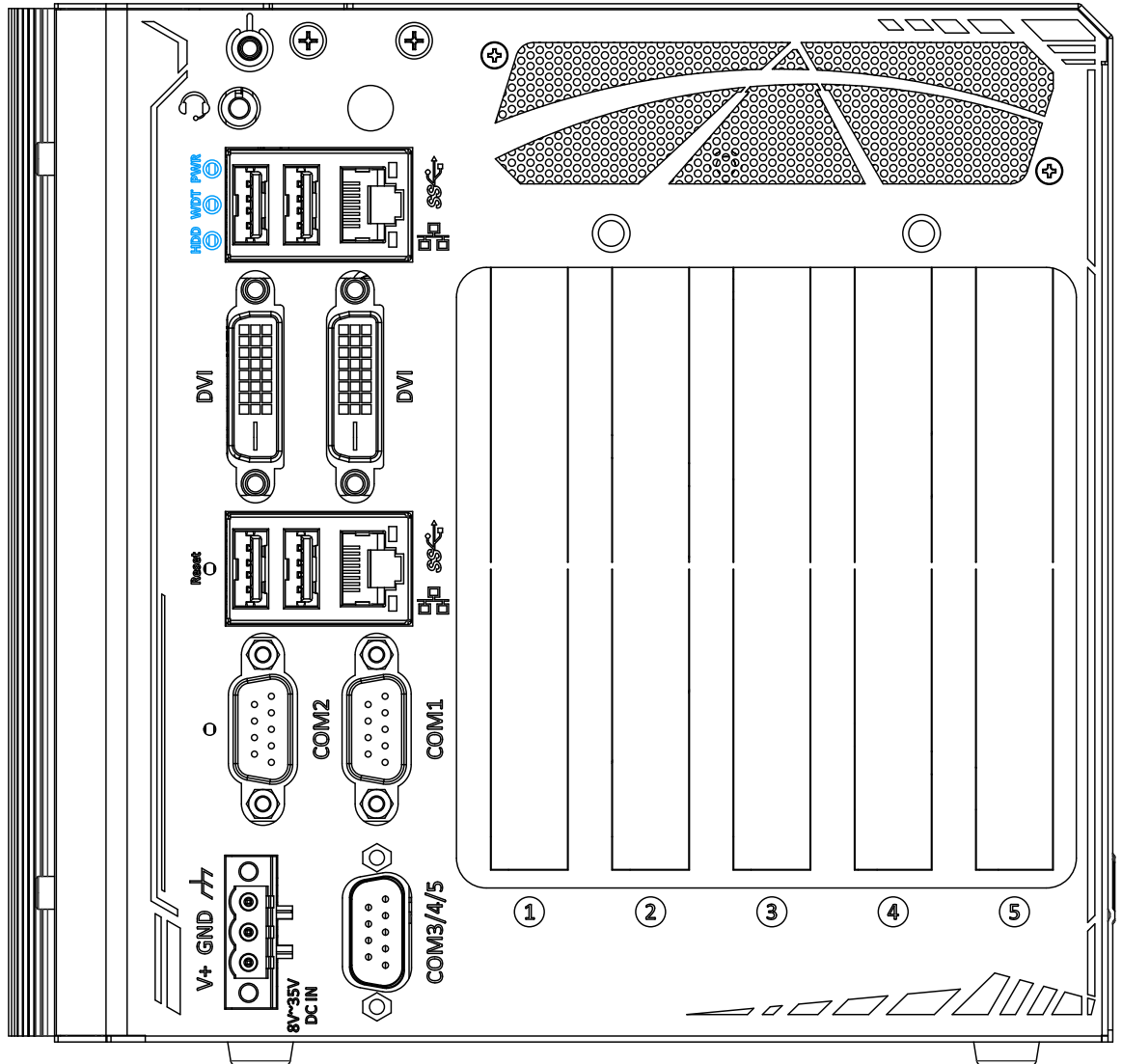

There are three LED indicators on the I/O panel. From top to bottom, they are power (PWR), Watchdog timer (WDT) and hard disk drive activity (HDD). The descriptions of these three LEDs are listed in the following table.

Indicator	Color	Description
PWR	Green	Power indicator, lit when system is on.
WDT	Yellow	Watchdog timer LED, flashing when WDT is active.
HDD	Red	Hard drive indicator, flashing when hard disk drive is active.

### 2.2.4 USB3.1 Gen 1 Port

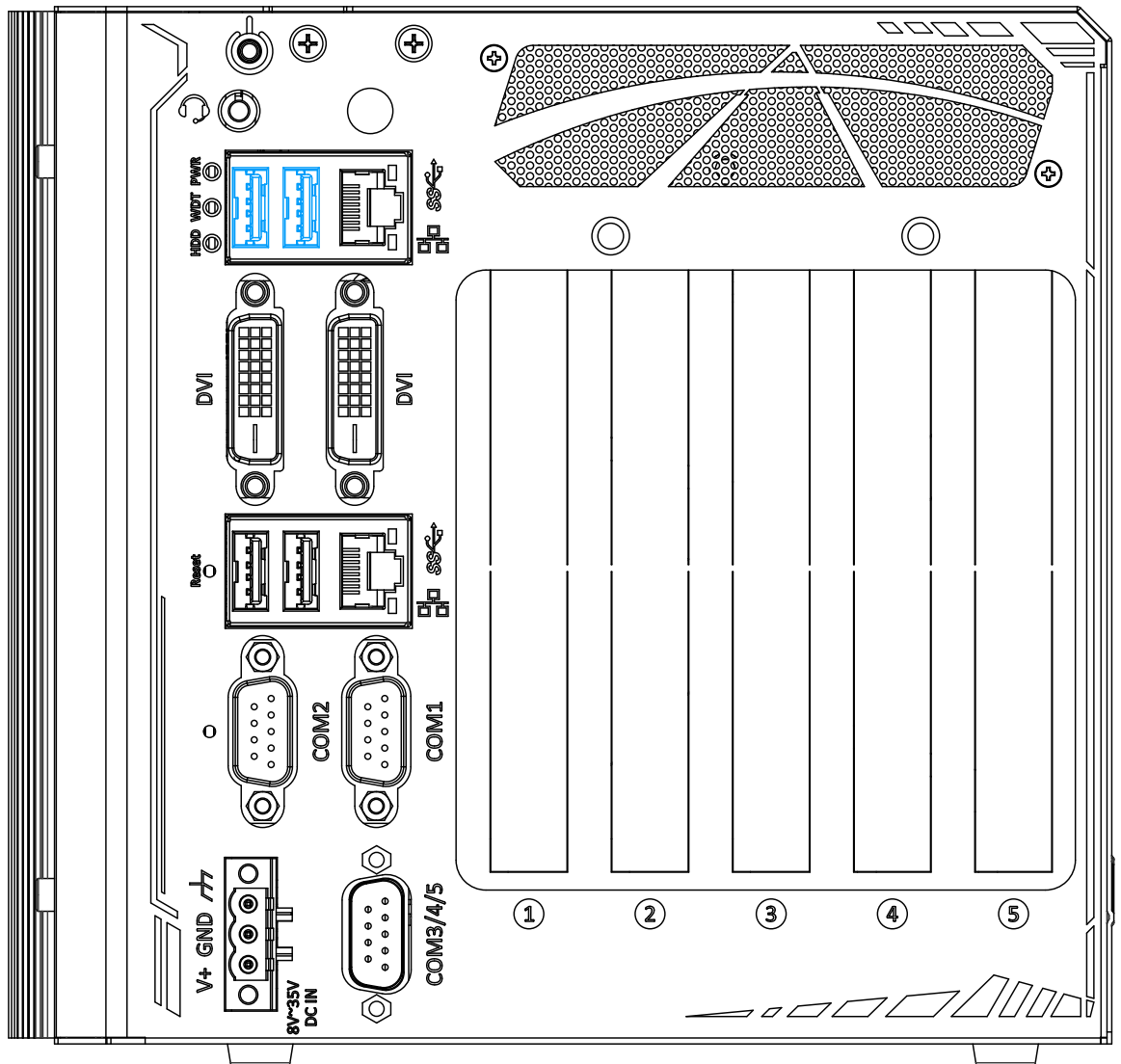

The system's USB 3.0 Gen 1 ports (5Gbps) are implemented via native xHCI (eXtensible Host Controller Interface) controller and are backward compatible with USB 2.0, USB 1.1 and USB 1.0 devices. Legacy USB is also supported so you can use USB keyboard/mouse in DOS environment. xHCI driver is supported natively in Windows 10, therefore you do not need to install xHCI driver in prior to utilize USB functions.

## 2.2.5 I210 Gigabit Ethernet Port

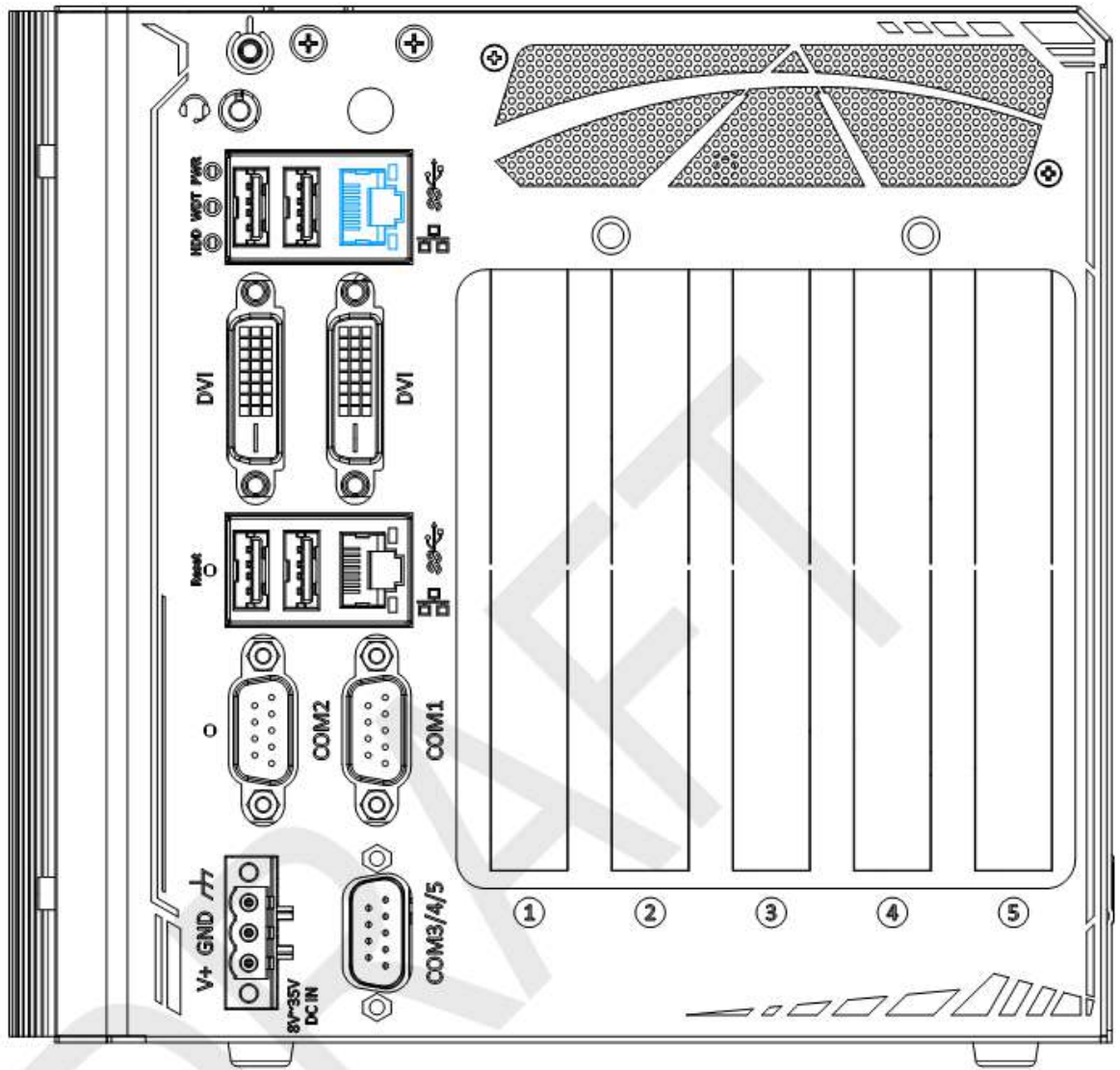

This Gigabit Ethernet port is implemented using Intel® I210-IT controller. The Ethernet port has one dedicated PCI Express link for maximum performance. Please refer to the table below for LED connection statuses.

### Active/Link LED

LED Color	Status	Description
Green	Off	Ethernet port is disconnected
	On	Ethernet port is connected and no data transmission
	Flashing	Ethernet port is connected and data is transmitting/receiving

### Speed LED

LED Color	Status	Description
Green or Orange	Off	10 Mbps
	Green	100 Mbps
	Orange	1000 Mbps

To utilize the GbE port in Windows, you need to install corresponding driver for Intel®

I210-IT/ I219-LM GbE controller.

## 2.2.6 DVI Port

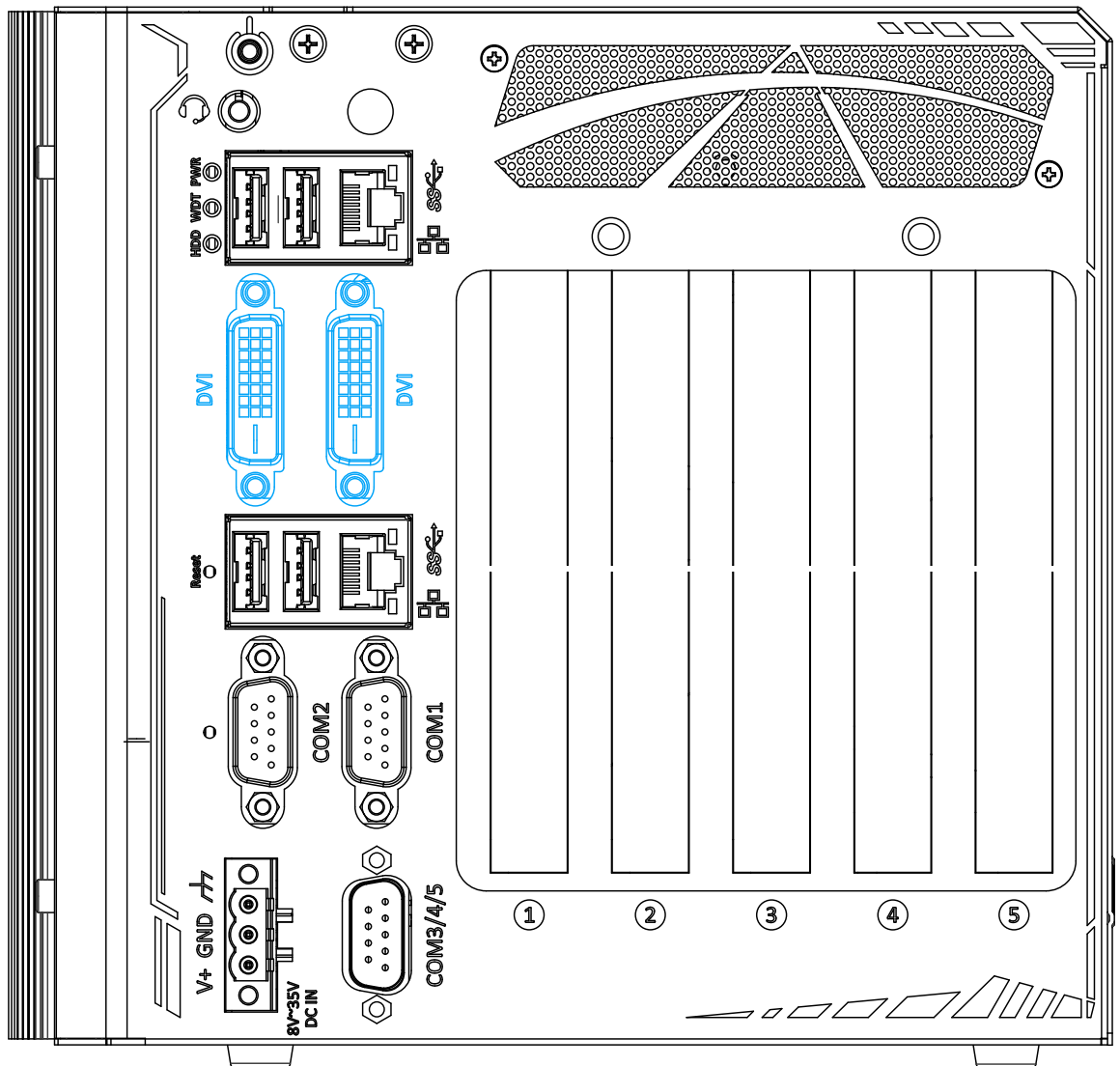

DVI-D transmits graphics data in digital format and therefore can deliver better image quality at high resolution. The DVI connector on the front panel can either output DVI signals or other digital signals (via an adapter/ cable) depending on the display device connected. It supports resolutions up to 1920x1200@60Hz.

The system supports dual independent display outputs by connecting display devices to the two DVI ports. To support multiple display outputs and achieve best DVI output resolution in Windows, you need to install corresponding graphics driver. Please refer to section OS Support and Driver Installation for details.

### 2.2.7 Reset Button

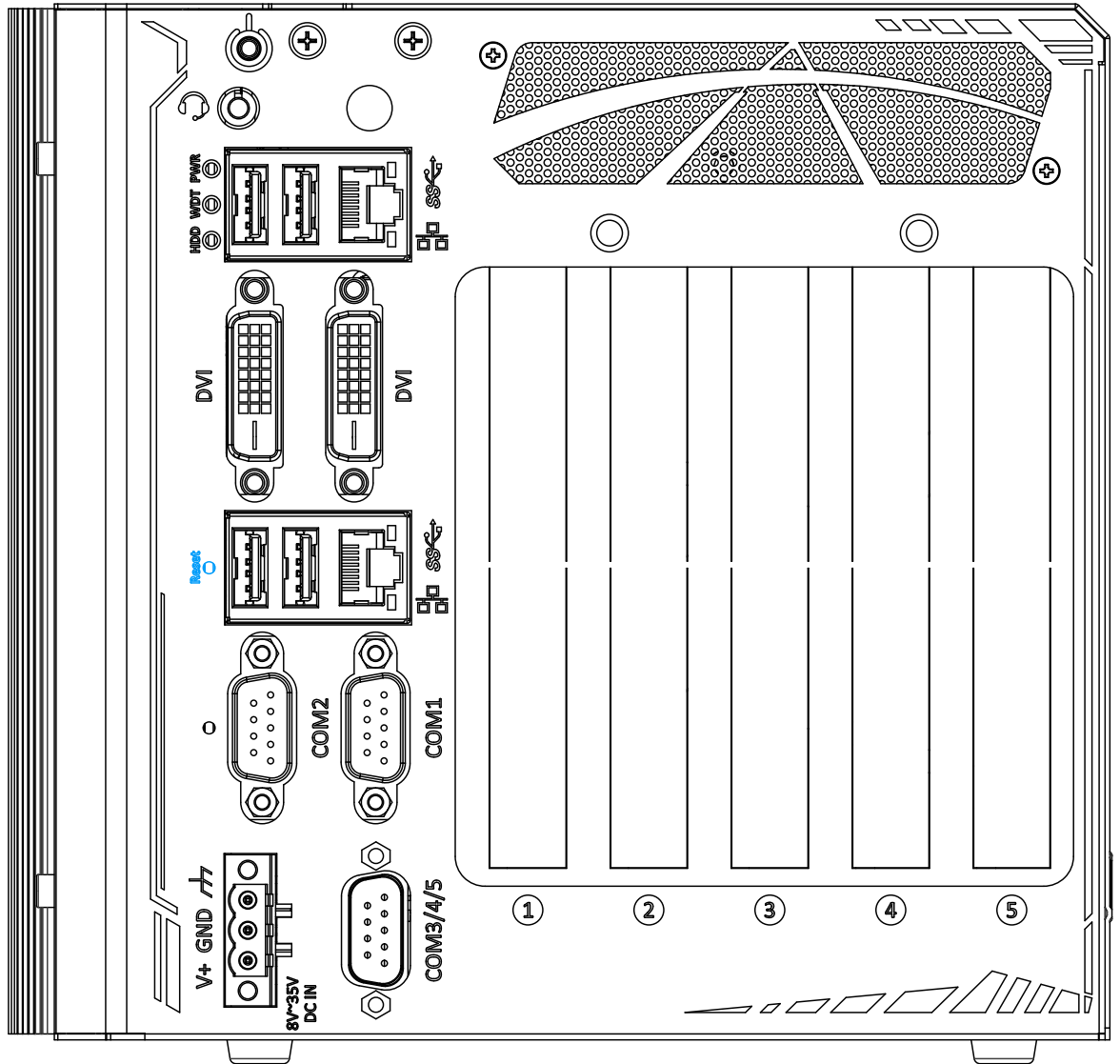

The reset button is used to manually reset the system in case of system halt or malfunction. To avoid unexpected reset, the button is purposely placed behind the panel. To reset, please use a pin-like object (eg. tip of a pen) to access the reset button



## 2.2.8 USB3.1 Gen 1 Port

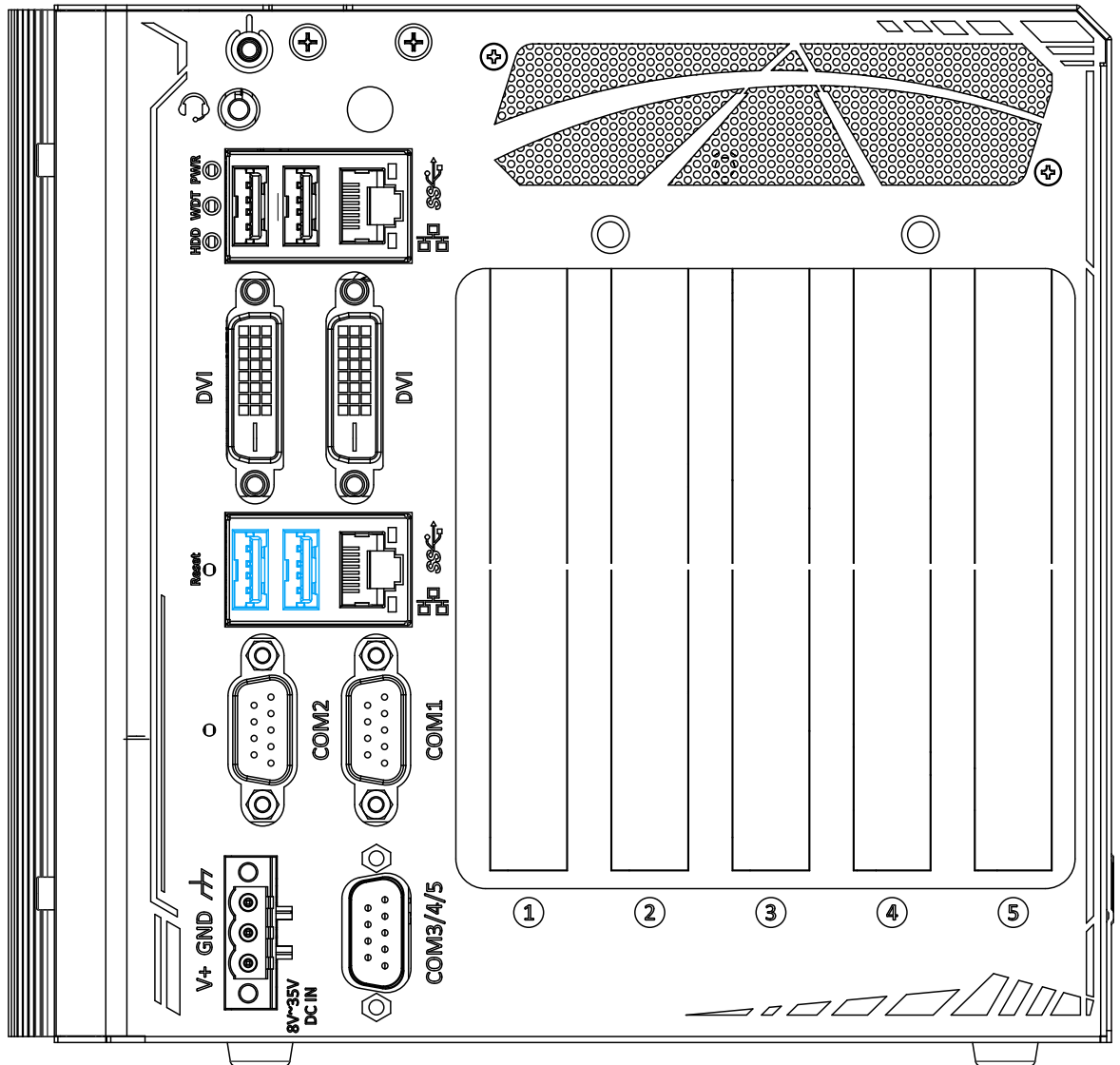

The system's USB 3.0 Gen 1 ports (5Gbps) are implemented via native xHCI (eXtensible Host Controller Interface) controller and are backward compatible with USB 2.0, USB 1.1 and USB 1.0 devices. Legacy USB is also supported so you can use USB keyboard/mouse in DOS environment. xHCI driver is supported natively in Windows 10, therefore you do not need to install xHCI driver in prior to utilize USB functions.

## 2.2.9 I219 Gigabit Ethernet Port

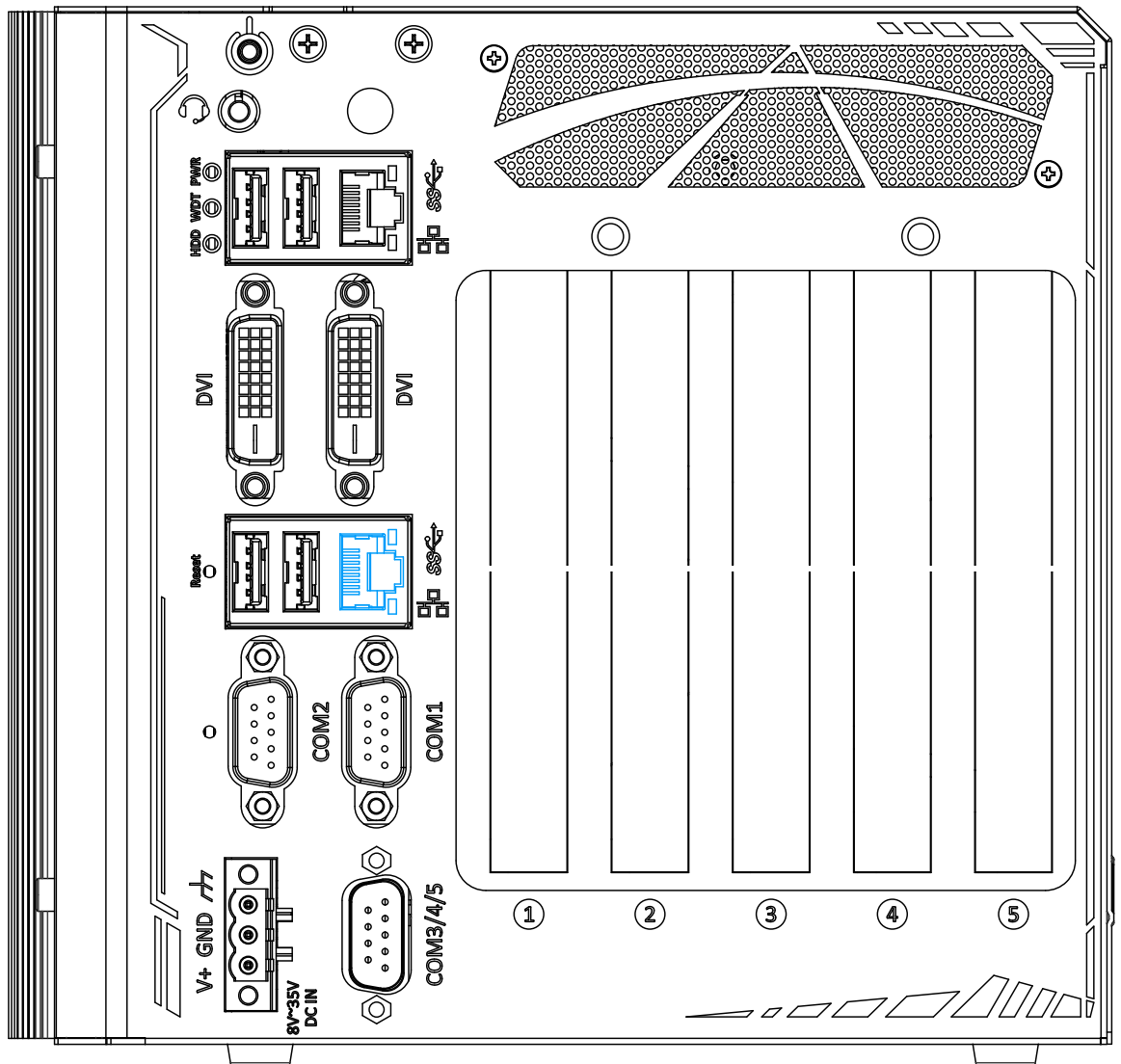

This Gigabit Ethernet port is implemented using Intel® I219-LM controller that supports Wake-on-LAN and is also compatible with Intel® AMT (Active Management Technology) to support advanced features such as remote SOL desktop and remote on/ off control. Each port has one dedicated PCI Express link for maximum performance. Please refer to the table below for LED connection statuses.

### Active/Link LED

LED Color	Status	Description
Green	Off	Ethernet port is disconnected
	On	Ethernet port is connected and no data transmission
	Flashing	Ethernet port is connected and data is transmitting/receiving

### Speed LED

LED Color	Status	Description
Green or Orange	Off	10 Mbps
	Green	100 Mbps
	Orange	1000 Mbps

To utilize the GbE port in Windows, you need to install corresponding driver for Intel® I210-IT/ I219-LM GbE controller.

### 2.2.10 COM2 Port

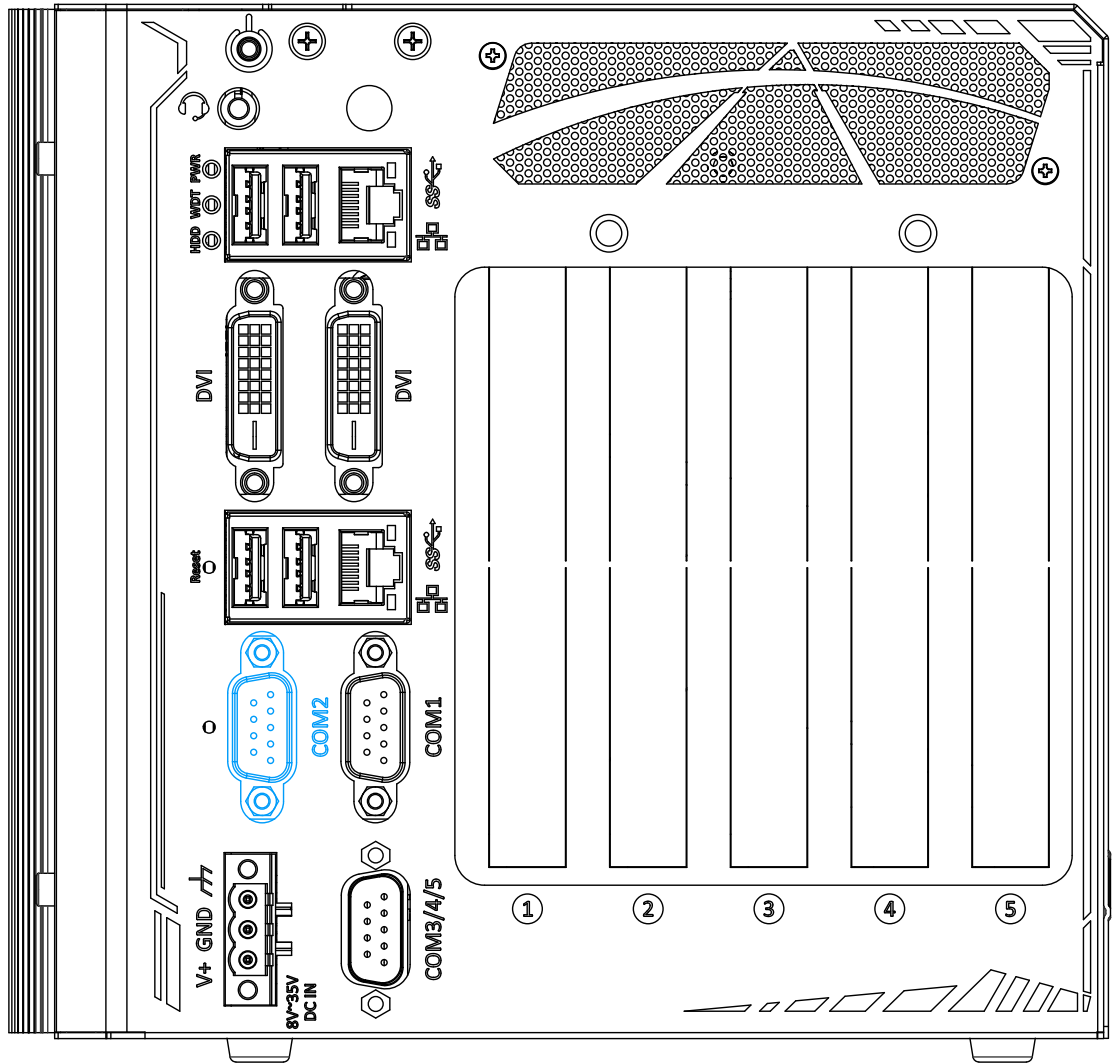

COM2 is a software-configurable RS-422/ 485 port. The operation mode of COM2 can be set in BIOS setup utility. Please note that there is no termination for RS-422/ 485. The following table describes the pin definition of COM port.

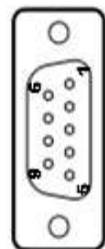

Pin#	COM2	
	RS-422 Mode	RS-485 Mode
1		
2	422 TXD+	485 TXD+/RXD+
3	422 RXD+	
4	422 RXD-	
5	GND	GND
6		
7		
8	422 TXD-	485 TXD-/RXD-
9		

### 2.2.11 COM1 Port

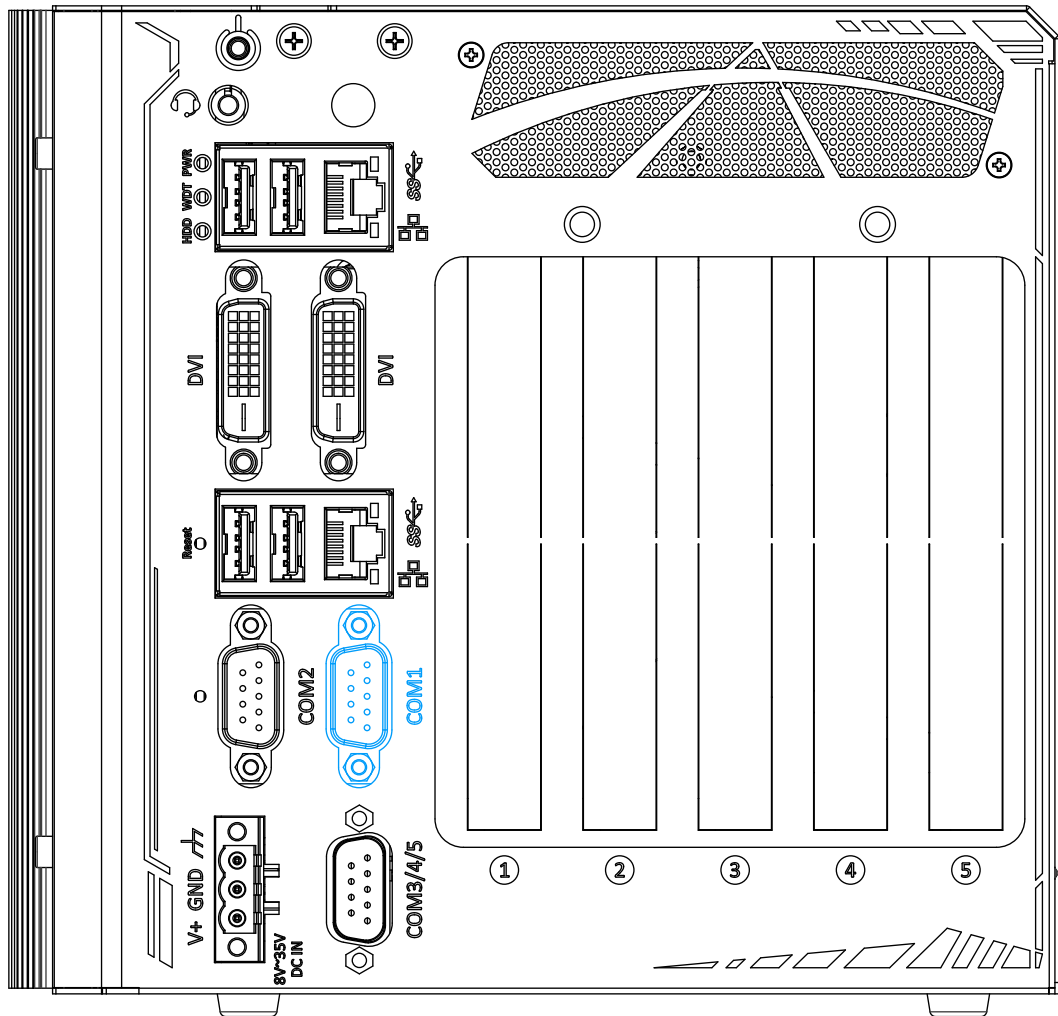

The COM1 port is implemented using industrial-grade ITE8786 Super IO chip (-40 to 85°C) and provide up to 115200 bps baud rate. It is a software-configurable RS-232/422/485 port. The operation mode of can be set in BIOS setup utility. The following table describes the pin definition of the COM port.

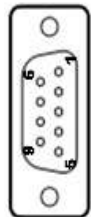

#### COM Port Pin Definition

Pin#	COM1		
	RS-232 Mode	RS-422 Mode	RS-485 Mode (Two-wire 485)
1	DCD		
2	RX	422 TXD+	485 TXD+/RXD+
3	TX	422 RXD+	
4	DTR	422 RXD-	
5	GND	GND	GND
6	DSR		
7	RTS		
8	CTS	422 TXD-	485 TXD-/RXD-
9	RI		

### 2.2.12 3-Pin Terminal Block for DC Input

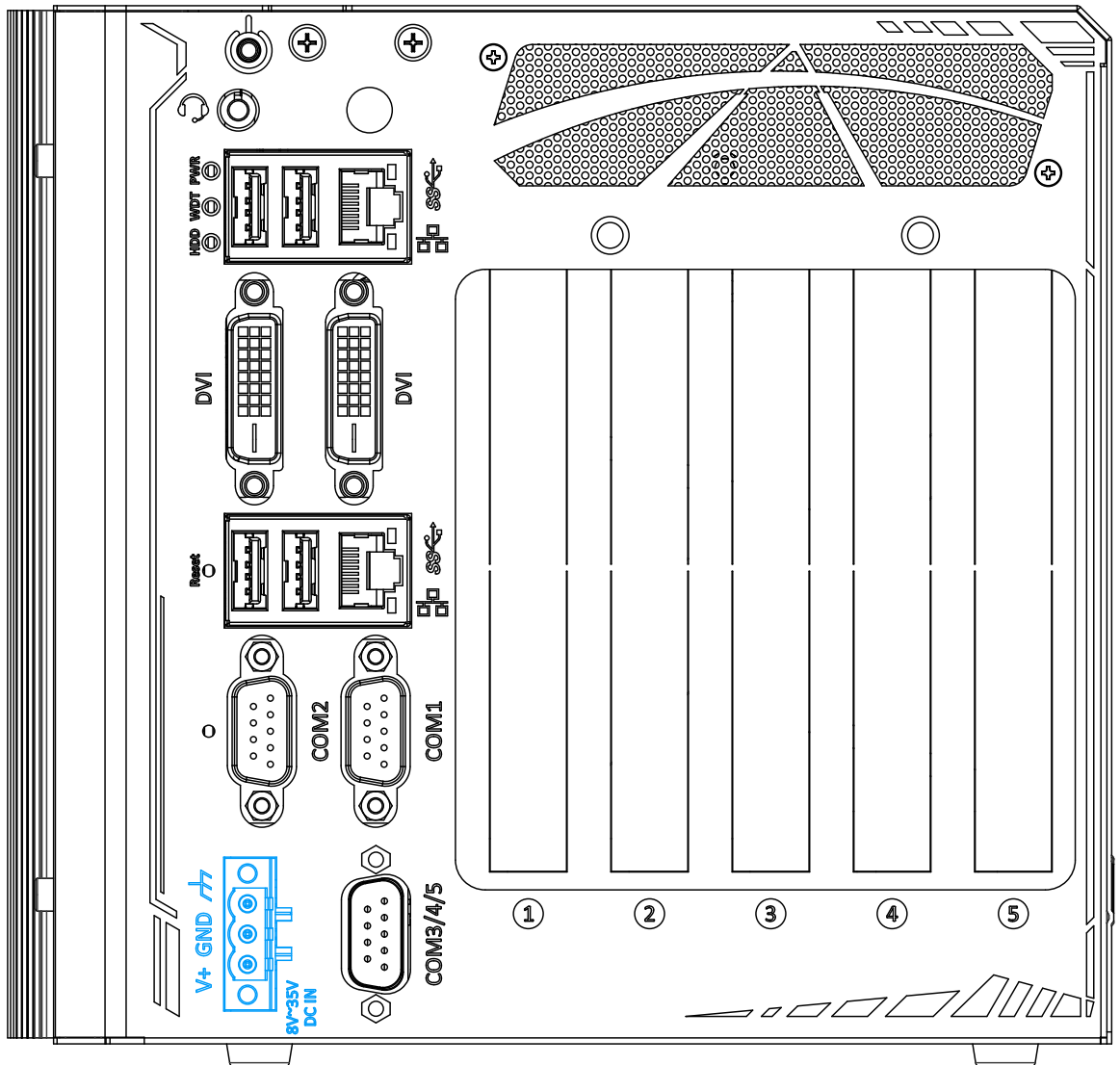

The system accepts a wide range of DC power input from 8 to 35V via 3-pin pluggable terminal block, which is fit for field usage where DC power is provided. And the screw clamping connection of the terminal block gives a very reliable way of wiring DC power.

Symbol	Description
	Chassis ground (connected to the earth ground)
<b>GND</b>	Negative polarity (ground) of DC input
<b>V+</b>	Positive polarity of DC input

 **WARNING**

*Please make sure the voltage of DC power is correct before you connect it to the system. Supplying a voltage over 35V will damage the system.*

### 2.2.13 COM3/ 4/ 5 Port

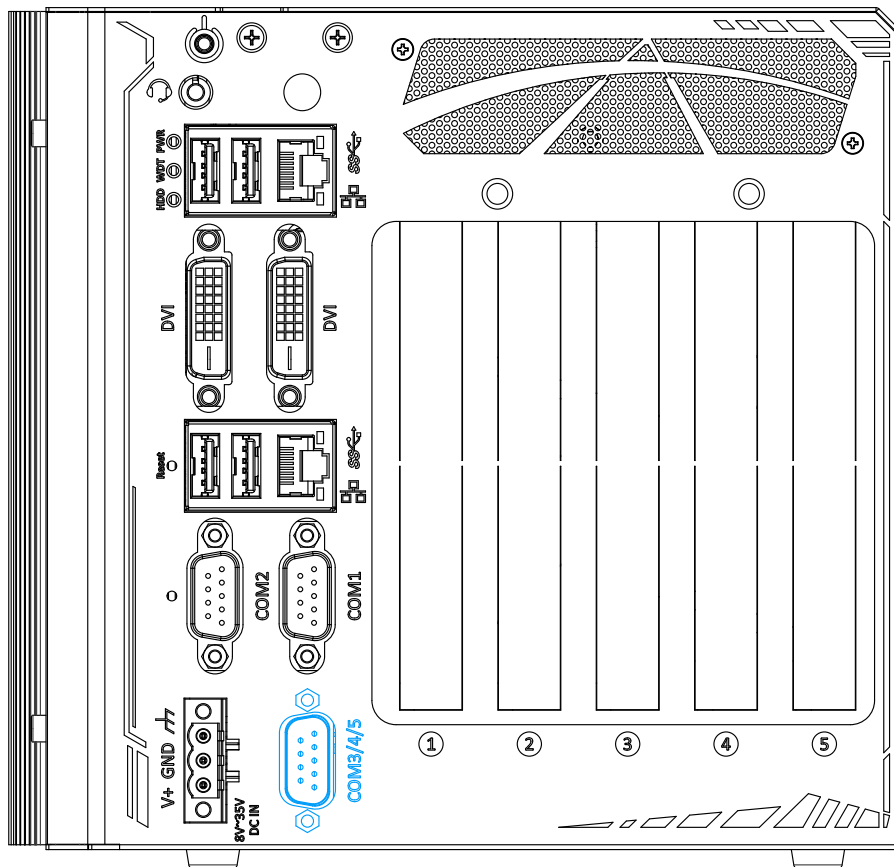

COM3, COM4 and COM5 are 3-wire RS-232 ports share single DB9 connector. You can directly connect this to one external device with 3-wire RS-232 interface, or use an optional 1-to-3 Y-cable to have three DB9 connectors for more devices. The following table describes the pin definition of the DB9 connector as well as the Y-cable.



Pin#	COM3/ 4/ 5 DB9		
	COM3	COM4	COM5
1			
2	RX		
3	TX		
4		TX	
5	GND	GND	GND
6		RX	
7			TX
8			RX
9			

Pin#	Y-Cable DB9
	COM3 (A)
1	
2	RX
3	TX
4	
5	GND
6	
7	
8	
9	

## 2.3 Internal I/O Functions

In addition to I/O connectors on the front panel, the system also provides internal on-board connectors, such as remote on/off control, LED status output, internal USB 2.0 ports, etc. In this section, we'll illustrate these internal I/O functions.

### 2.3.1 SODIMM DRAM Slot

The system motherboard supports single module DDR4 2666MHz SODIMM up to 32GB capacity.

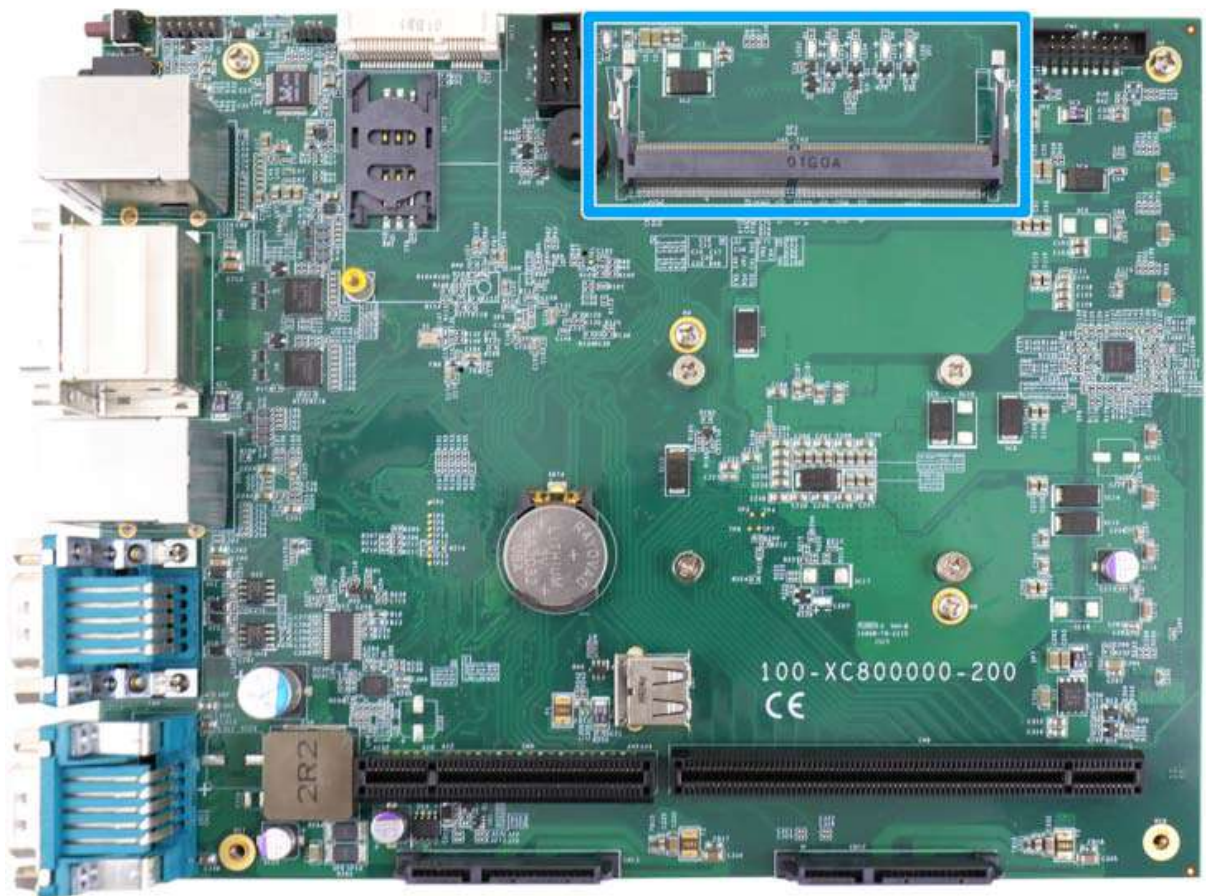

#### NOTE

*When changes are made to DRAM module(s), such as additionally install or remove and re-install (into the same/ different slot, it will result in an approximately 30~60 seconds delay when booting up for the first time after such change(s).*

### 2.3.2 mSATA Slot & Pin Definition

The system provides an mSATA slot (indicated in **blue**) mux with USB 2.0 signal to accommodate an mSATA flash disk module. The mSATA flash disk module is a solid-state storage device with SATA interface and is reliable for harsh environments and has high tolerance for intense vibration/shock conditions. The system recognizes mSATA as a native storage device and accordingly you can install any operating system on the mSATA module. This mSATA socket is designed with a SIM card slot (indicated in **red**) support. With a SIM card installed, your system can access the internet via your network provider's 4G/ 5G network.

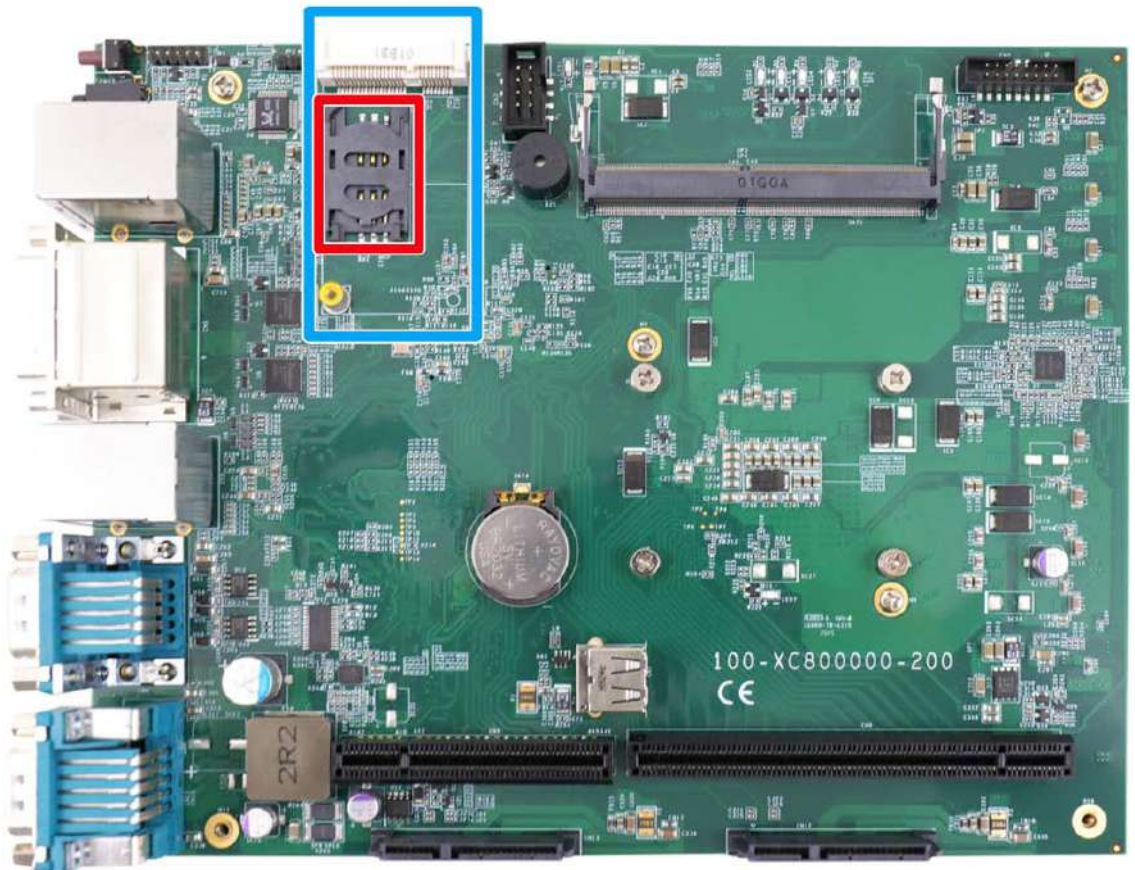

For wireless (WIFI/ 3G/ 4G) communication, an SMA antenna aperture can be located on the front panel.

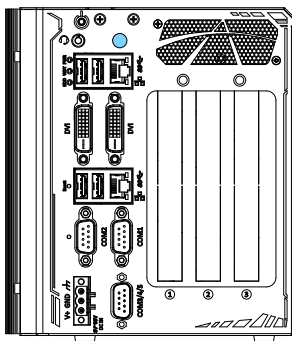

Nuvo-8003

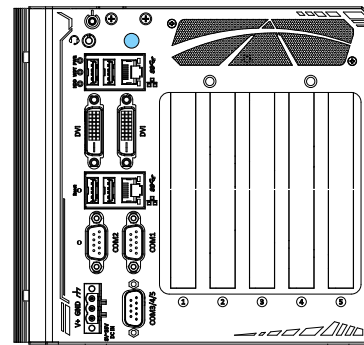

Nuvo-8023/ 8032/ 8041



**mSATA/ USB2.0 signal definition**

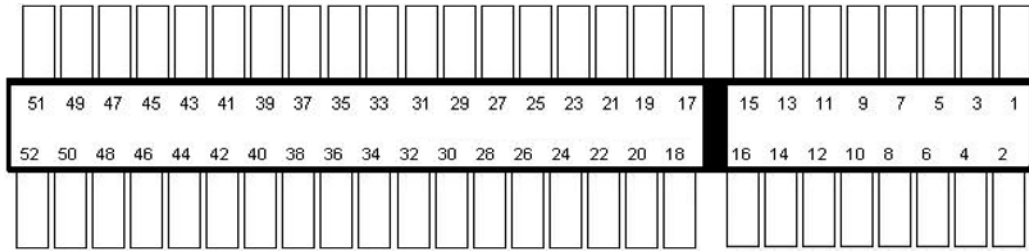

Pin#	Signal (USB)	Signal (mSATA)	Pin #	Signal (USB)	Signal (mSATA)
1	-	-	2	+3.3V	3.3V
3	-	-	4	GND	GND
5	-	-	6	+1.5V	+1.5V
7	-	-	8	UIM_PWR	-
9	GND	GND	10	UIM_DATA	-
11	-	-	12	UIM_CLK	-
13	-	-	14	UIM_RESET	-
15	GND	GND	16	UIM_VPP	-
<b>Mechanical Key</b>					
17	-	-	18	GND	GND
19	-	-	20	W_DISABLE#	-
21	GND	GND	22	-	-
23	-	SATA_Rxp	24	3.3V	3.3V
25	-	SATA_Rxn	26	GND	GND
27	GND	GND	28	+1.5V	+1.5V
29	GND	GND	30	SMB_CLK	SMB_CLK
31	-	SATA_Txn	32	SMB_DATA	SMB_DATA
33	-	SATA_Txp	34	GND	GND
35	GND	GND	36	USB_D-	-
37	GND	GND	38	USB_D+	-
39	3.3V	3.3V	40	GND	GND
41	3.3V	3.3V	42	-	-
43	GND	-	44	-	-
45	-	-	46	-	-
47	-	-	48	+1.5V	+1.5V
49	-	-	50	GND	GND
51	-	-	52	3.3V	3.3V

### 2.3.3 SATA Ports



NOTE

*Supports up to 15mm thickness HDD/ SSD.*

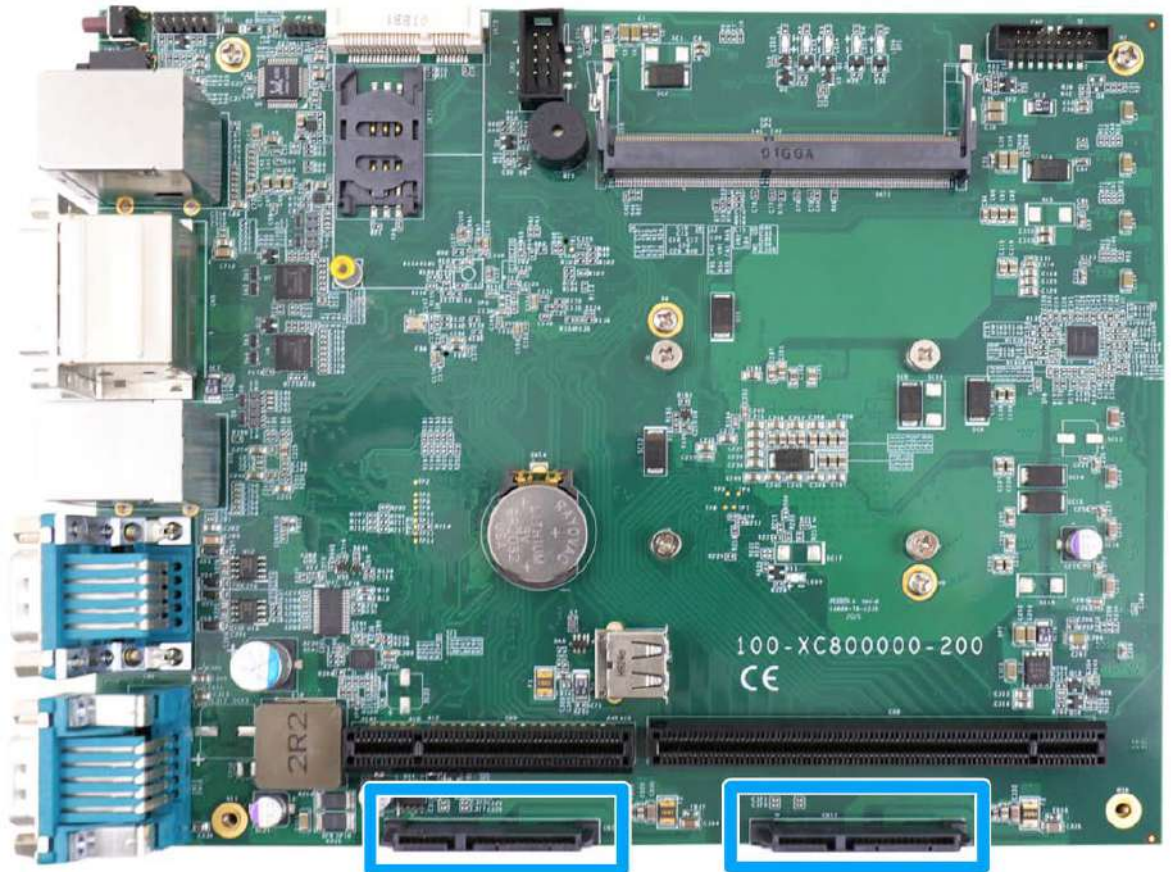

The system provides two SATA ports which support Gen3, 6 Gb/s SATA signals via standard 22-pin SATA connectors are provided with the system. You may refer to the SATA Configuration section for SATA settings.

### 2.3.4 On/ Off Ctrl & Status Output

For an application which places Nuvo-8000 inside a cabinet, it's useful to output the system status to external LED indicators so that users can check how the system's running. Nuvo-8000 provides a 2x6, 2.0mm pitch pin header to output system status such as power, HDD, watchdog timer, and control system on/off remotely. The status LED output has a built-in series-resistor and provides 10mA current to directly drive the external LED indicators. System on/off control is also provided so you can use an external non-latched switch to turn on/off the system exactly the same as the power button on the front panel. The following table describes the pin definition of the status LED output.

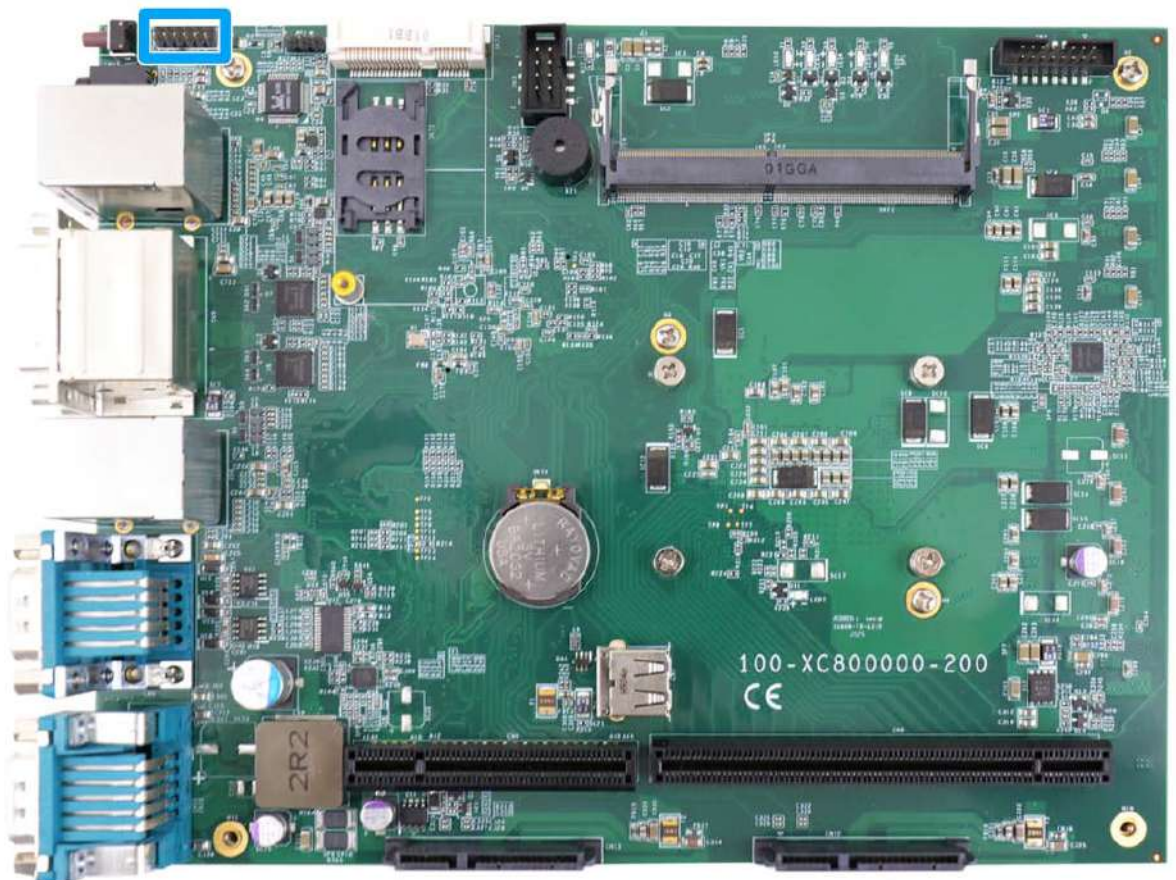

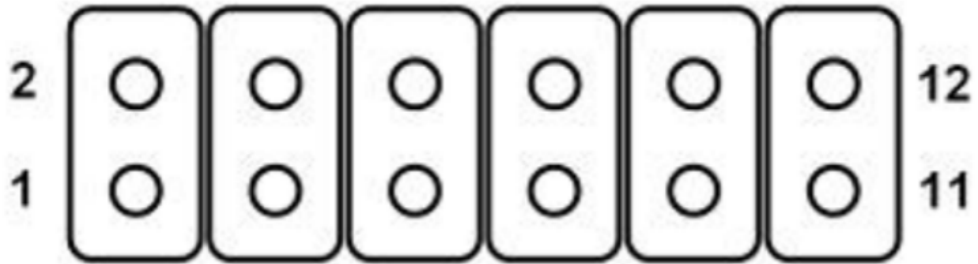

Pin#	Definition	Description
1	WDT_LED-	[Output] Watchdog timer indicator, flashing when Watchdog timer is active
2	WDT_LED+	
3	UID_LED-	[Output] User defined LED, reserved for future usage
4	UID_LED+	
5	HDD-	[Output] Hard drive indicator, flashing when SATA hard drive is active.
6	HDD+	
7	Power_LED-	[Output] System power indicator, on if system is turned on, off if system is turned off.
8	Power_LED+	
9	Ctrl-	[Input] Remote on/off control, connects to an external switch to turn on/off the system (polarity is negligible).
10	Ctrl+	
11	NA	Un-used pin
12	NA	

### 2.3.5 Internal USB 2.0 Port

The system provides additional two USB 2.0 ports internally via a 2x8 pins, 2.0mm pitch box header. The internal USB ports are designed to allow users attaching additional USB devices inside the chassis. To use the internal USB port, you shall need a dedicated box-header to USB cable. Please contact Neousys for further information.

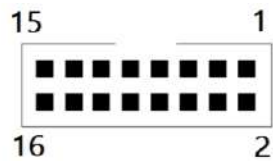
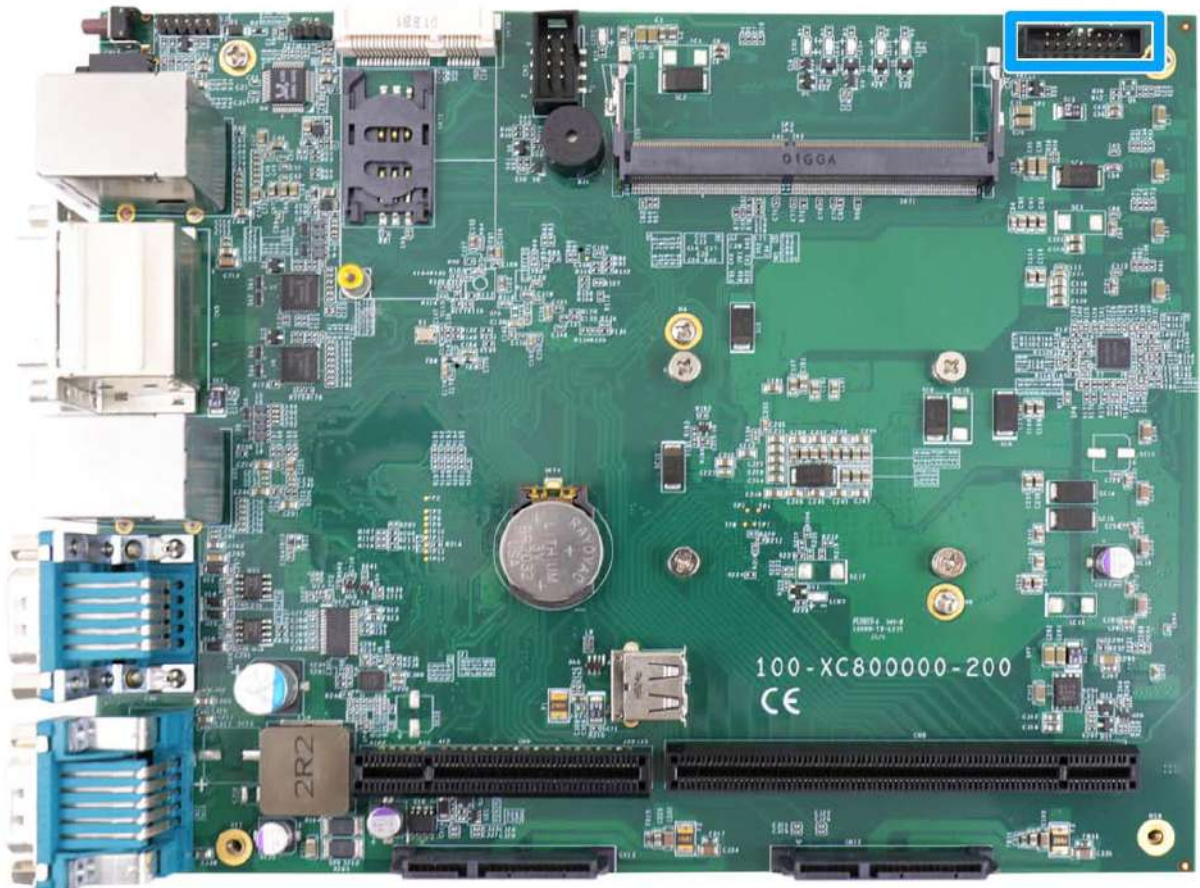

Pin#	Pin Definition
1	USB 5V Power, Max 500mA
2	USB 5V Power, Max 500mA
3	USB6 D-
4	USB7 D-
5	USB6 D+
6	USB7 D+
7	Ground
8	Ground
9 ~ 16	N/C

## 3 System Installation

Before disassembling the system enclosure and installing components and modules, please make sure you have done the following:

- It is recommended that only qualified service personnel should install and service this product to avoid injury or damage to the system.
- Please observe all ESD procedures at all times to avoid damaging the equipment.
- Before disassembling your system, please make sure the system has powered off, all cables and antennae (power, video, data, etc.) are disconnected.
- Place the system on a flat and sturdy surface (remove from mounts or out of server cabinets) before proceeding with the installation/ replacement procedure.

### 3.1 Disassembling the System



#### NOTE

*Nuvo-8000 series systems share the same disassembly screws locations and only differ in their enclosure size. For demonstration purposes, an illustration matching Nuvo-8023/ 8032/ 8041 will be used in the following sections.*

To access system internal components, the system needs to be disassembled. To disassemble the system enclosure, you need to remove the Chassis and screws on both I/O panels.

1. On the I/O panel, remove the screw indicated.



2. Remove the screws indicated on the side panel.



3. Remove the screw indicated on the rear panel.





4. Gently lift the L-shape cover panel to separate it from the enclosure.



5. Once the L-shaped panel has been removed, you can gain access to all internal expansion slots and components.

## 3.2 Installing Internal Components

### 3.2.1 CPU Installation Procedure

1. To install the CPU, you will need to separate the heatsink and the motherboard, please refer to the section "[Disassembling the System](#)".
2. Once you have remove the L-shaped panel, looking from the top, remove the screws indicated securing the daughterboard.



3. Gently wiggle to disengage the daughterboard from the motherboard.



**NOTE**

*Please disengage the daughter-board gradually as there are capacitors situated underneath the PCIe slots that may come in contact with enclosure structures when removed with excessive force.*

4. To separate the motherboard/heatsink from the enclosure, remove the COM 3/4/5 hexa-screws indicated on the I/O panel.



5. Remove the screws indicated on the heatsink.

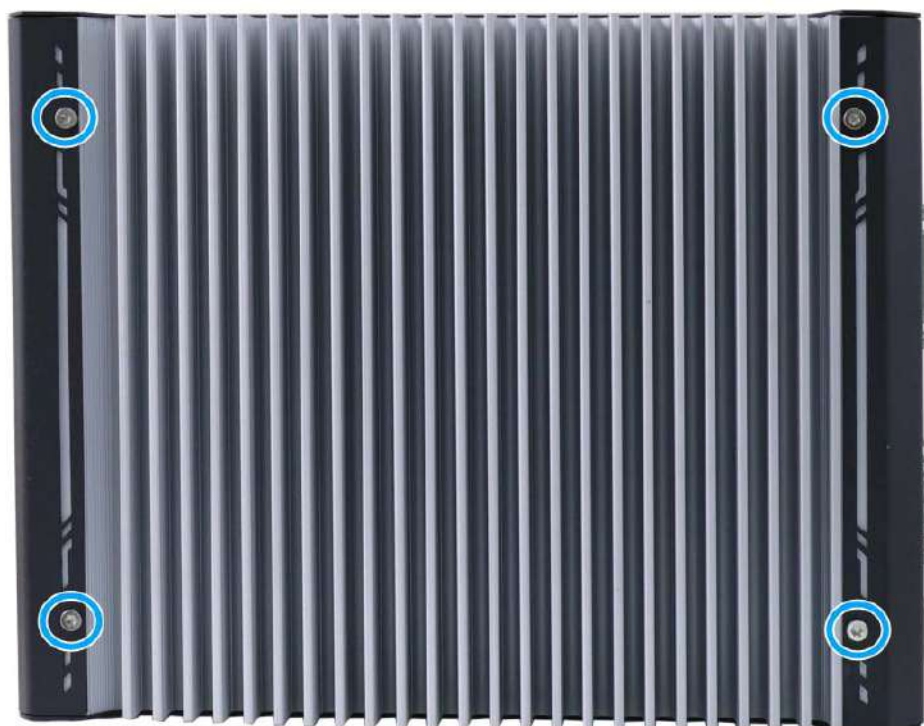

- Gently lift and separate the motherboard/ heatsink from the enclosure.



- To separate the motherboard from the heatsink, remove the screws indicated **blue** and if there are screws (indicated in **red**) secured in the following locations, please remove them as well before separating the motherboard from the heatsink.

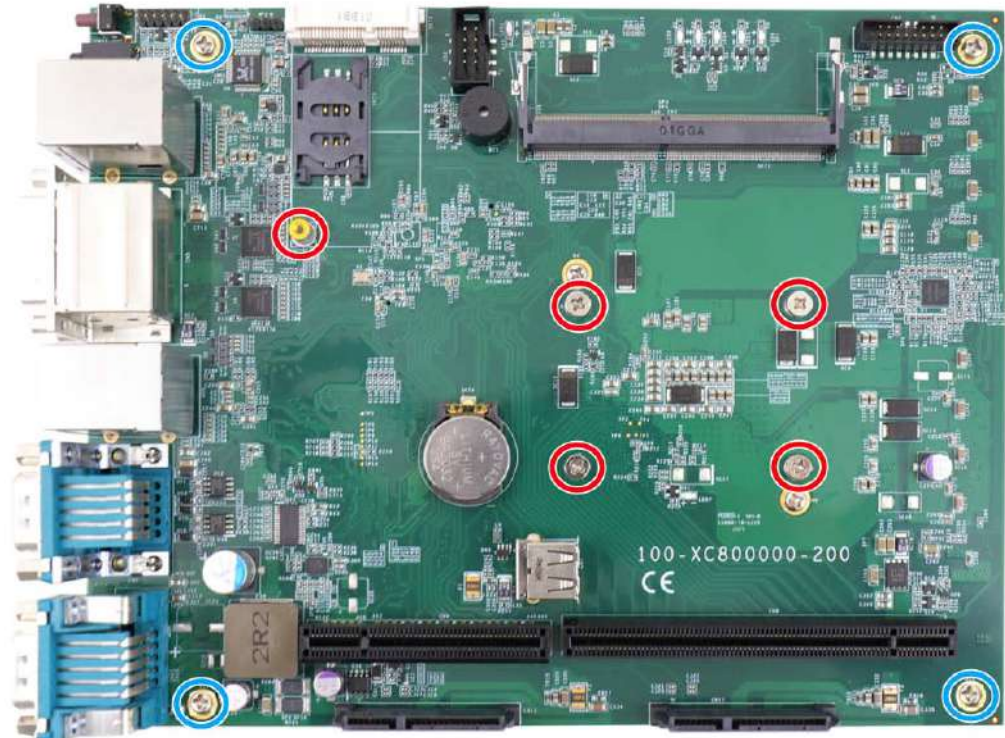

8. If you are installing the CPU for the first time, you will see the CPU socket protective cover, place finger tips underneath the sign "REMOVE" for leverage and gently lift the cover.

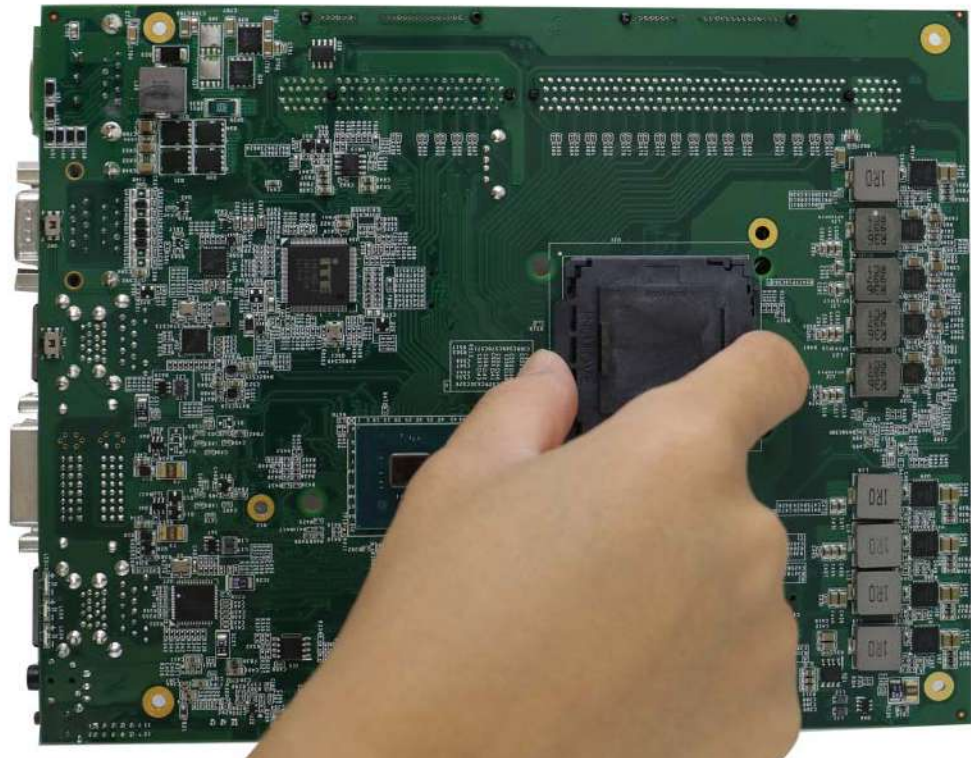

 **WARNING**

*With the protective cover removed, please be careful when handling the motherboard. DO NOT touch the pins in the LGA socket!*

9. Remove the CPU from its container/ tray. Match the two notches on the side to the protrusions in the socket, gently lower the CPU into the socket.



10. Locate the CPU retention bracket from the accessory box. Place the retention bracket on the CPU and hold it in place.



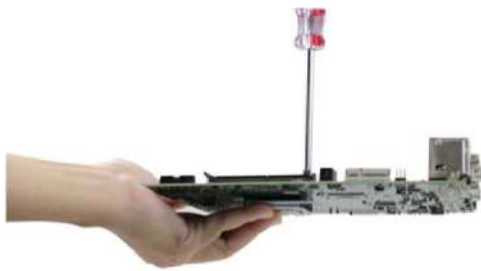
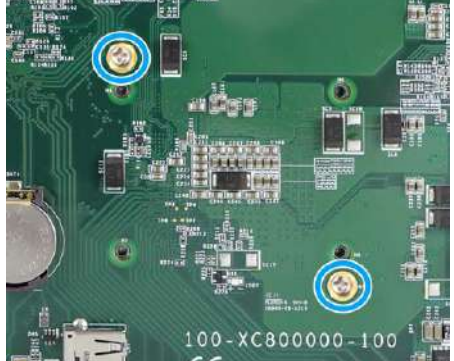

- Turn the motherboard around and secure the bracket by tightening two M3 P-head screws.

	
<p><b>Hold the bracket in place and turn the motherboard around</b></p>	<p><b>Secure the bracket using the two M3 P-head screws provided</b></p>

- If you are installing the CPU for the first time, remove thermal pads' protective films on the heatsink.

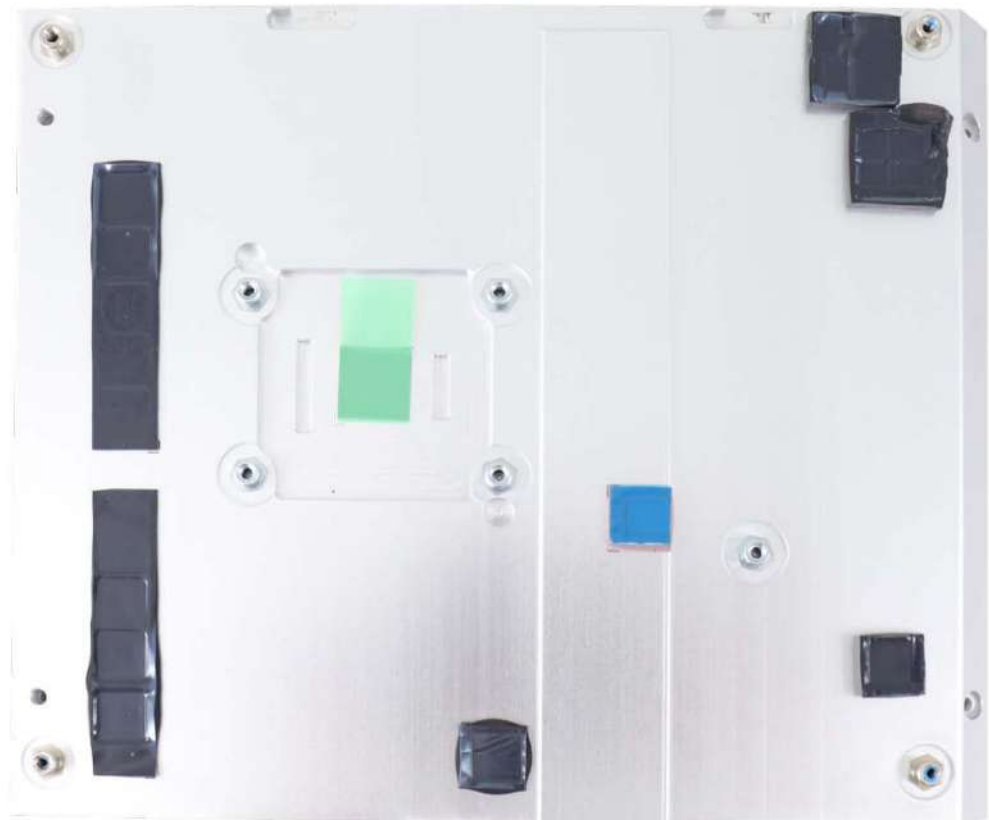

13. With the four motherboard standoffs aligned, gently lower the motherboard onto the heatsink and secure the four screws.

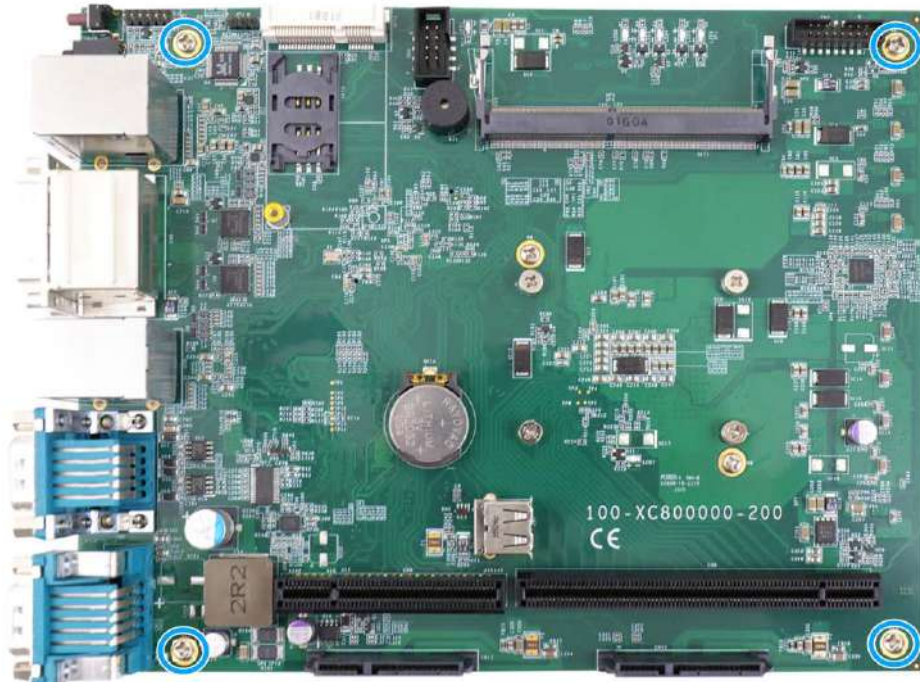

14. Once the motherboard has been installed, you're ready to secure the screws that help the heatsink apply pressure to the CPU/ chipset die. You'll want to apply even pressure to the corners by gradually tightening each screw. Please refer to the recommended order when tightening the screws.

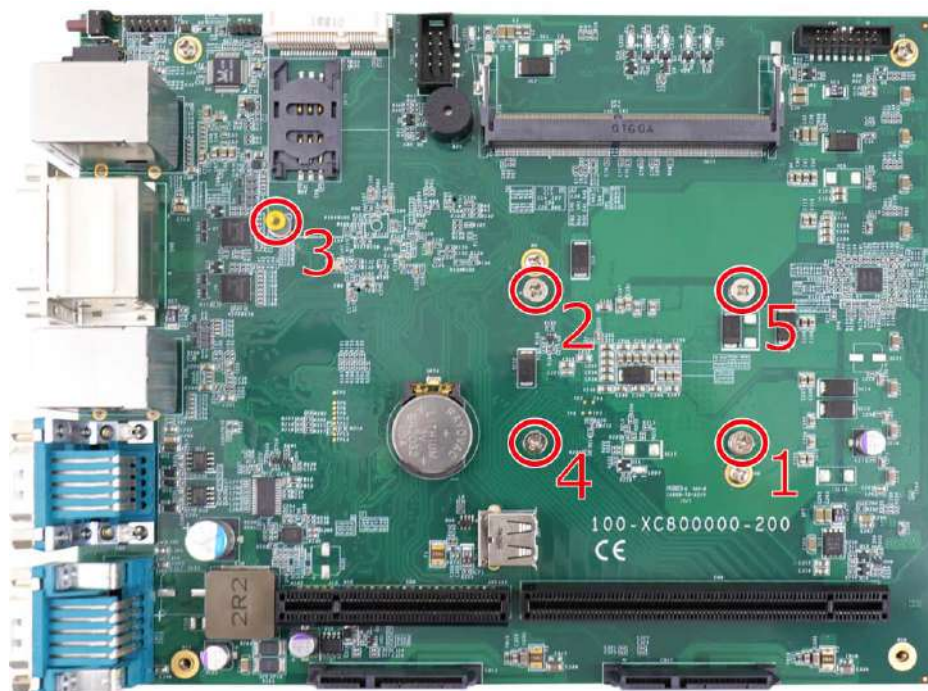

15. To install other components, please refer to respective sections.

### 3.2.2 DDR4 SO-DIMM Installation

There is a SO-DIMM memory slot (indicated in **blue**) on the motherboard that supports a total maximum of 32GB non-ECC DDR4-2666. Please follow the procedures below to replace or install the memory modules.

1. Please refer to the section "[Disassembling the System](#)".
2. Locate the SODIMM memory module slots on the motherboard.

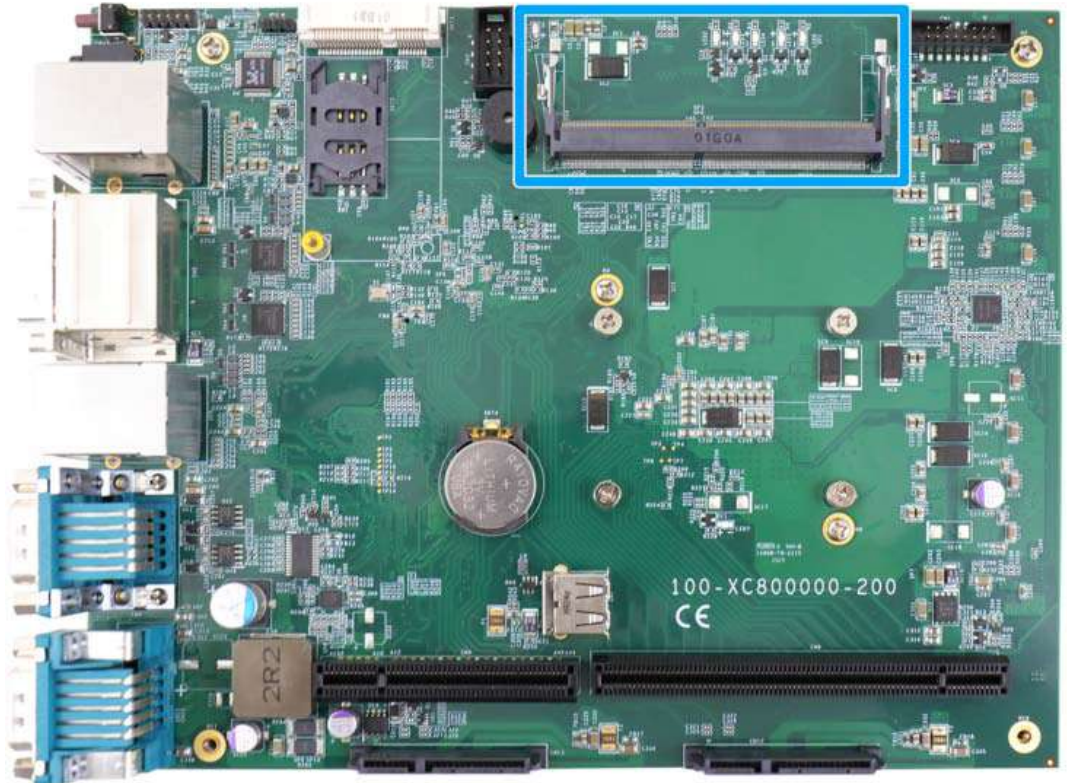

3. To install the memory module, insert gold fingers into the slot at 45-degree angle, push down on the memory module to clip the module into position.



4. Push the memory module down until it is clipped-in.



5. Repeat steps 3 and 4 to install the other module.
6. [Reinstall the system enclosure](#) and panel when done.
7. If you need to install other components, please refer to respective sections.

### 3.2.3 mSATA, Mini-SIM (2FF) Card and Antennae Installation

The system has an mSATA slot (indicated in **blue**) coupled with mini-SIM socket (indicated in **red**) for installing 4G/ 5G module. For installation, please refer to the following instructions.

1. Please refer to the section "[Disassembling the System](#)".
2. Locate the mSATA and SIM card slots on the motherboard.

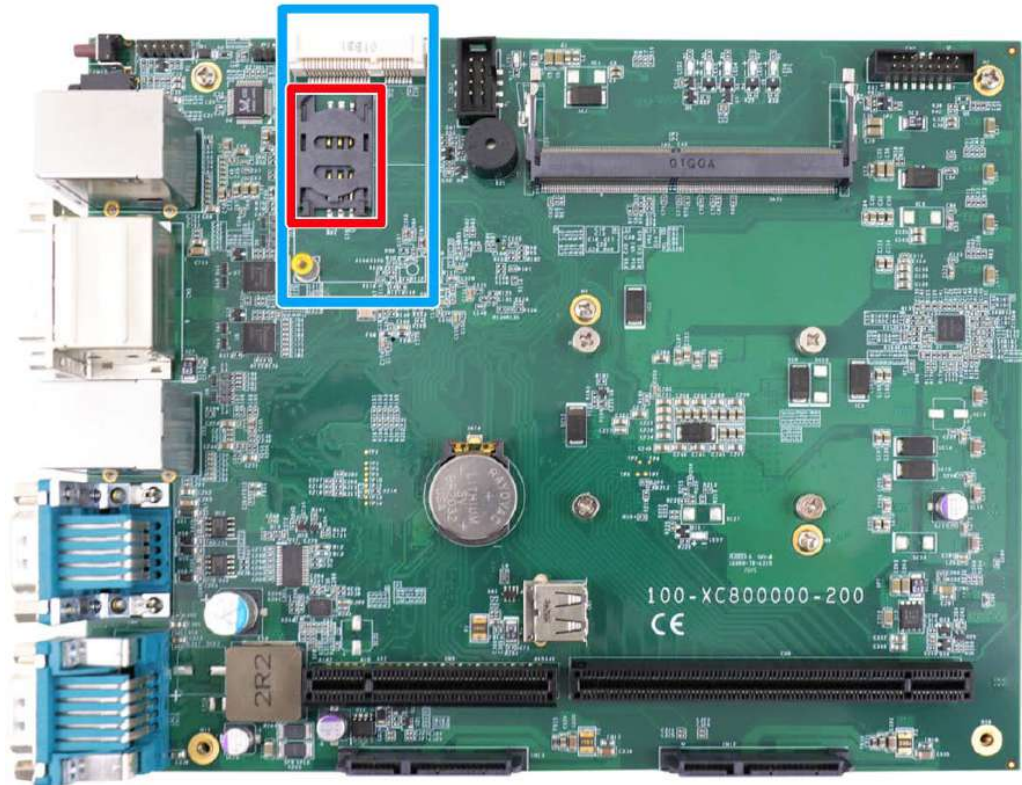

3. Before installing the mSATA module, you need to insert the Mini-SIM card. Slide the SIM slot holder and lift the SIM card holder. Insert the Mini-SIM card (pins facing up), shut the SIM holder and slide it to lock the SIM card in-place.

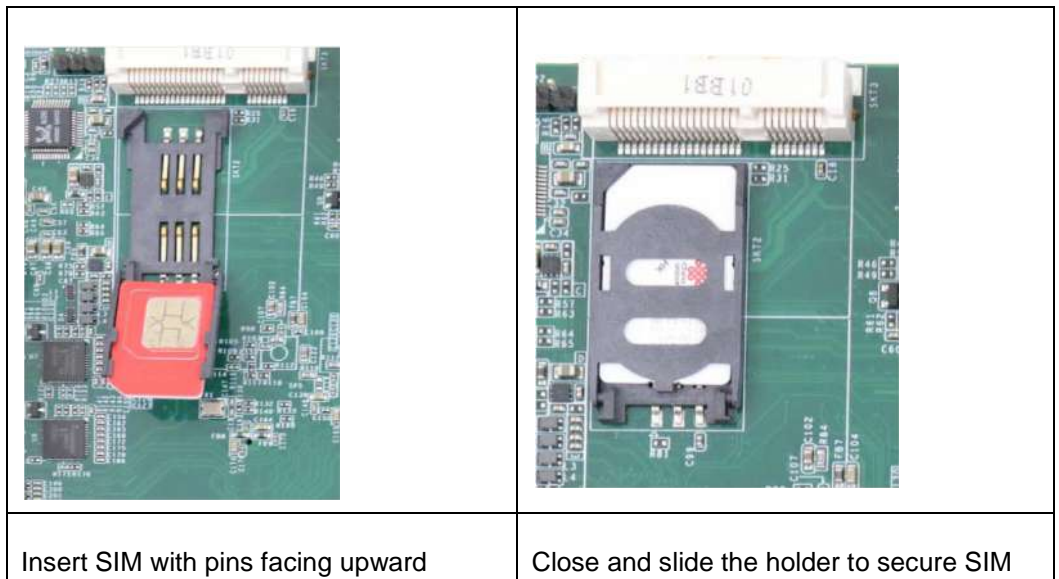

4. Insert the mPCIe module on a 45 degree angle into the mPCIe slot and secure the module with an M3 P-head screw.



5. Clip on the IPEZ-to-SMA cable to the module and secure the antenna to the front or rear panel. Please refer to the module's manual for clip-on connection.



**Clip on IPEZ-to-SMA cable**

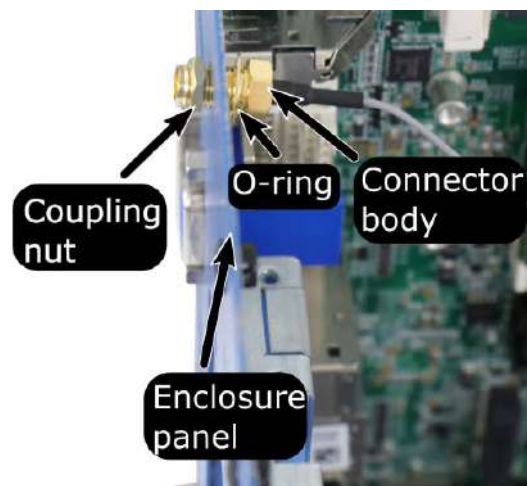

**Secure antenna to rear panel**

6. Secure the external antenna to complete the installation.
7. [Reinstall the system enclosure](#) and panel when done.
8. If you need to install other components, please refer to respective sections.

### 3.2.4 HDD/ SSD Installation



**NOTE**

*Supports up to 15mm thickness HDD/ SSD.*

The system has two SATA ports (indicated in **blue**). Please refer to the following instructions on how to install 2.5" SATA HDD/ SSD.

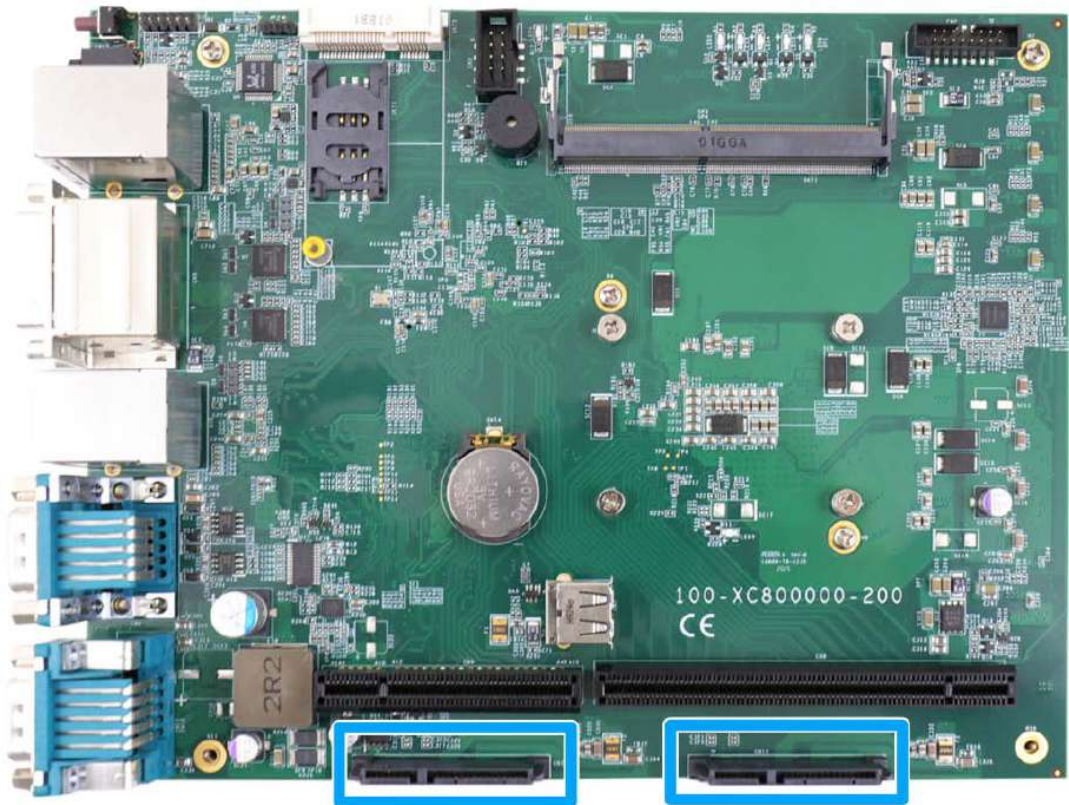

1. Please refer to the section "[Disassembling the System](#)".

- The HDD/ SSD tray is situated at the bottom, just underneath the daughterboard. To retrieve the tray, remove the screws indicated and gently pull out the tray.

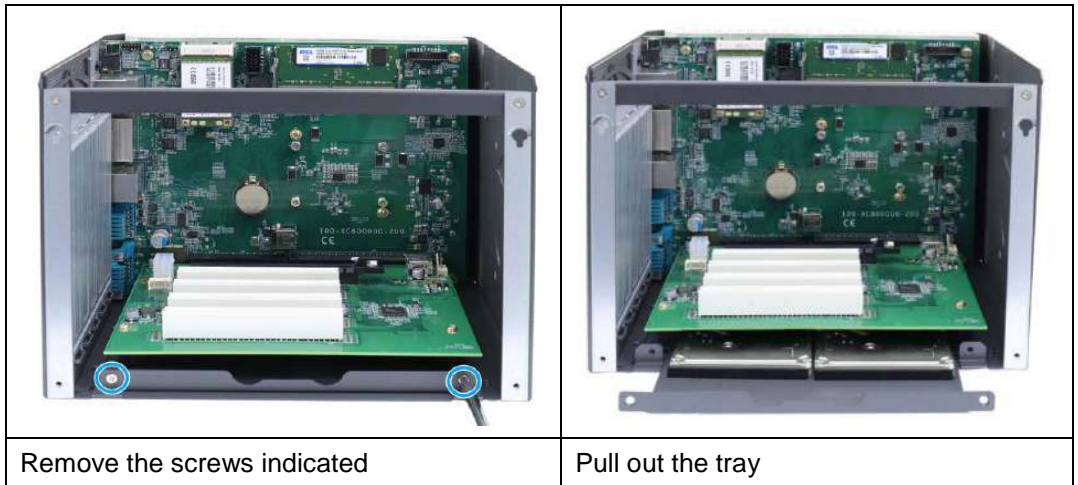

- With the SATA connectors facing inwards (indicated in blue), secure the HDD/ SSD with flathead screws from underneath the tray. You may install just one or two HDDs/ SSDs.



- Once the HDDs/ SSDs have been secured, insert the tray 3/4 of way in, firmly and gently push the tray into place. When HDDs/ SSDs have properly engaged the connector, secure the screws holding the tray in place.





### 3.3 Installing the System Enclosure

1. To reinstall the system enclosure, take the L-shaped panel, make sure the two notches inside the panel have been properly inserted into the slide-and-lock holes on enclosure frames.

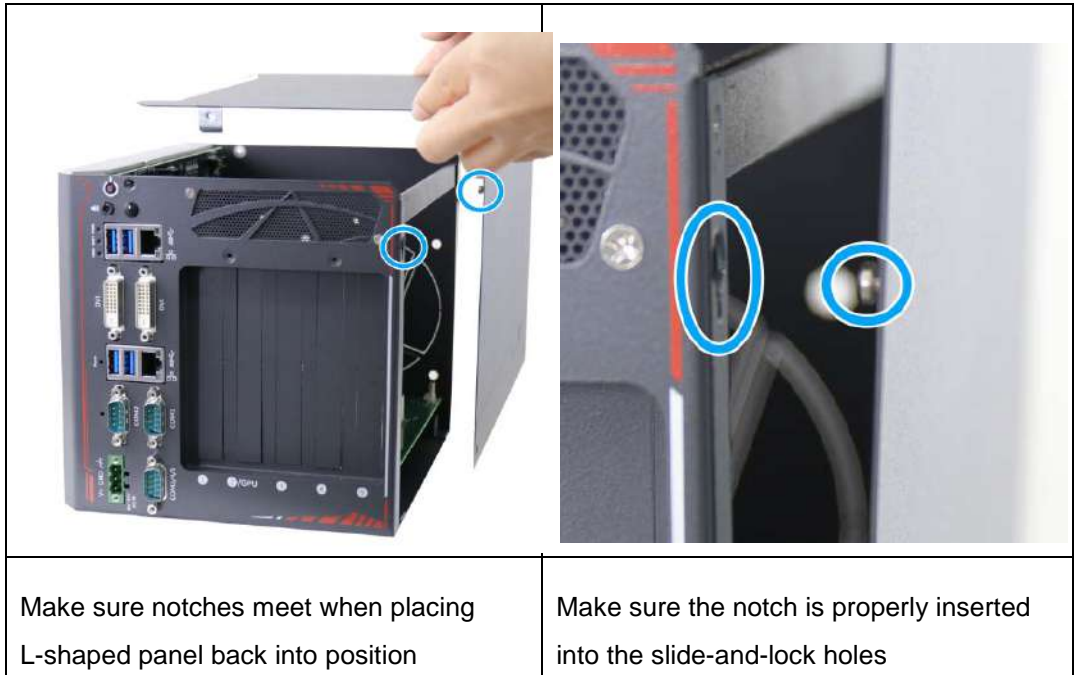

2. Secure the screw indicated on the I/O panel.



- Secure the screws indicated on the side panel.



- Secure the screw indicated at the rear to complete the enclosure installation.



### 3.4 Wall-mount Bracket Installation

To install the wall-mount bracket, please refer to the exploded illustration below on installing the wall-mount bracket. The bracket and screws can be found in the accessory box.

1. Secure the wall-mount bracket (in blue) with the supplied M4 screws (in red).

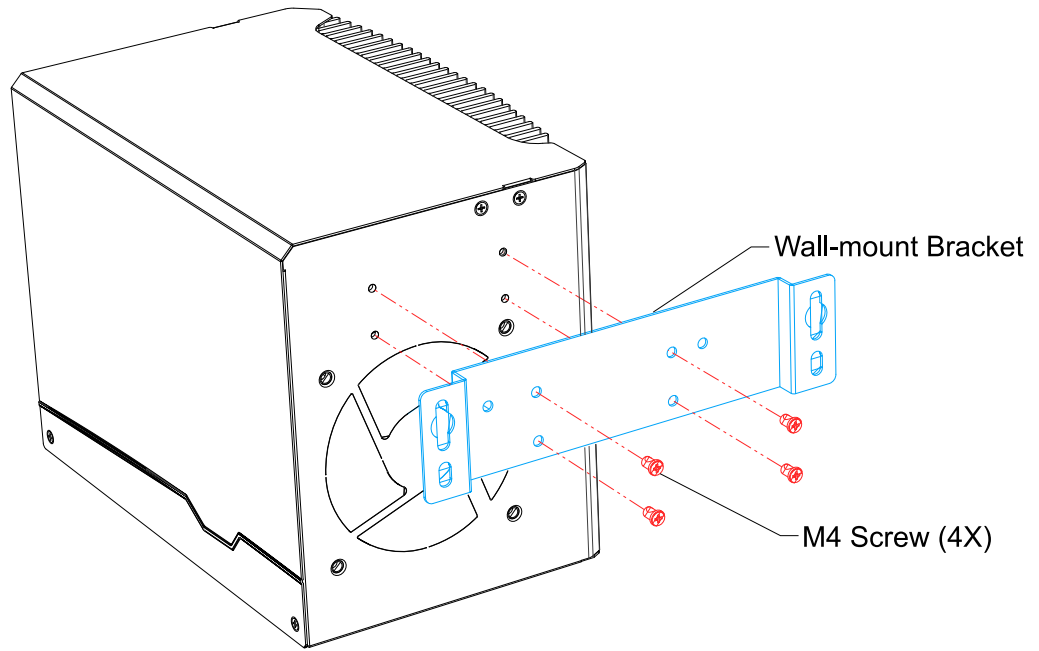

**Nuvo-8003**

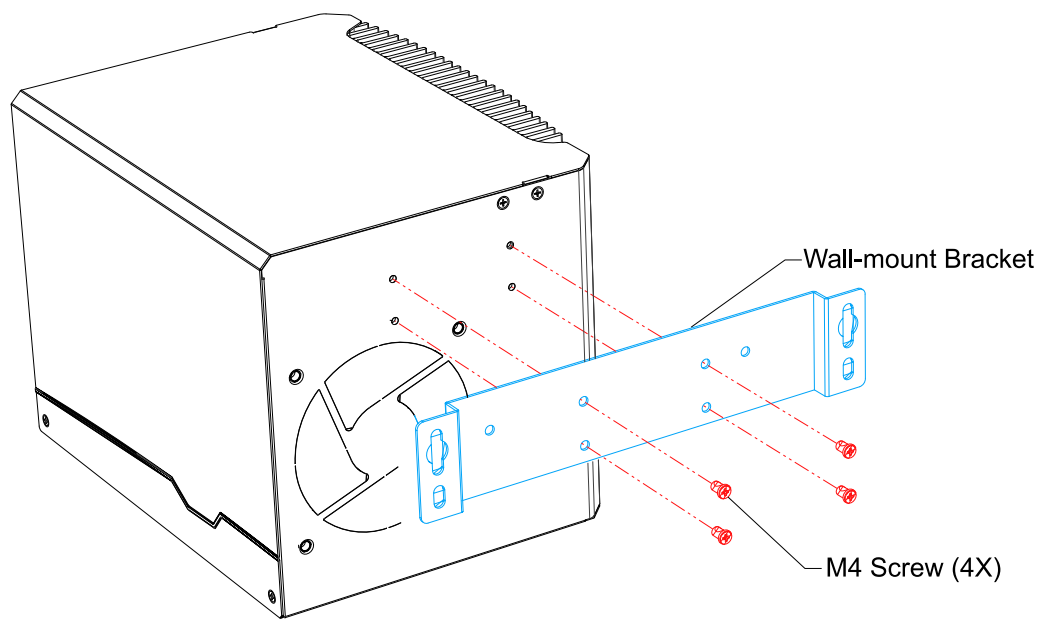

**Nuvo-8023/ 8032/ 8041**

2. Place the system on a flat surface and secure it with screws.

### 3.5 DIN-rail Installation (Optional)

The Nuvo-8000 series also comes with an optional DIN rail mounting kit. Please refer to the following procedure to install the DIN rail kit.

1. Secure the DIN rail clip (in blue) with the supplied M4 screws (in red).

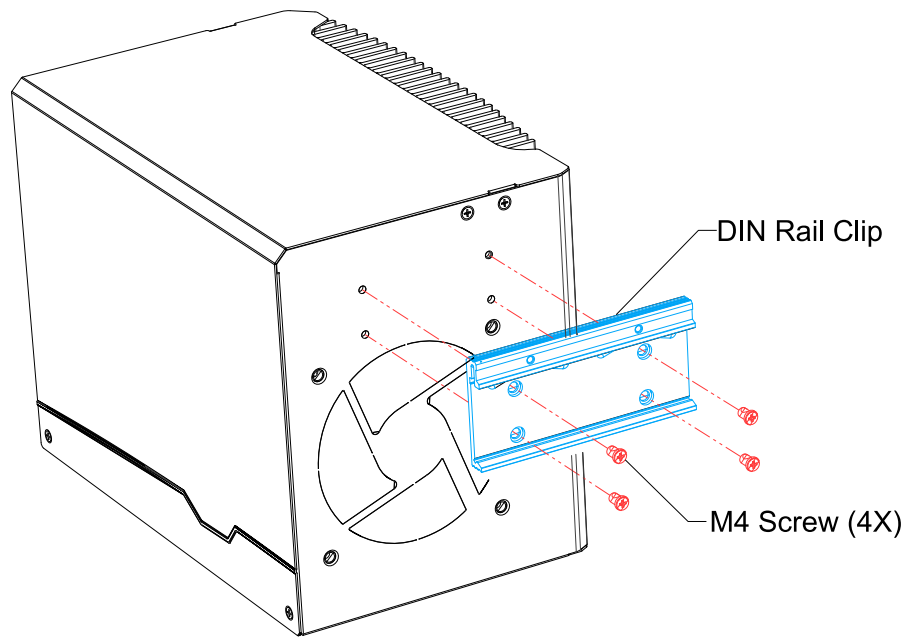

**Nuvo-8003**

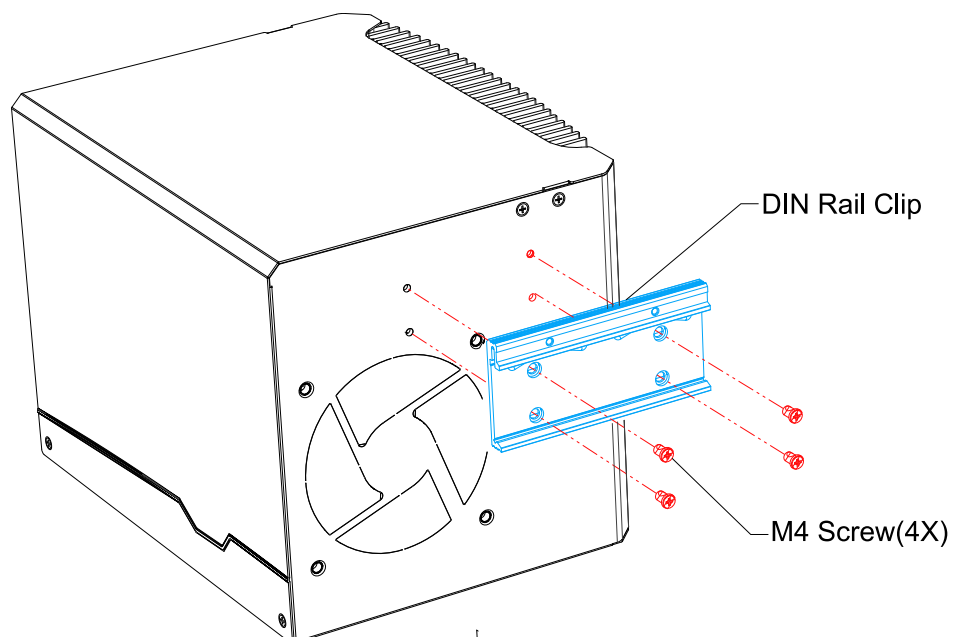

**Nuvo-8023/ 8032/ 8041**

- To install the DIN rail clip onto the DIN rail, you must come over the top of the DIN rail, tilting, overlap the top clip edge of the DIN rail clip onto the DIN rail first, and then firmly press the bottom-front of the enclosure to clip the bottom edge of the mount plate.

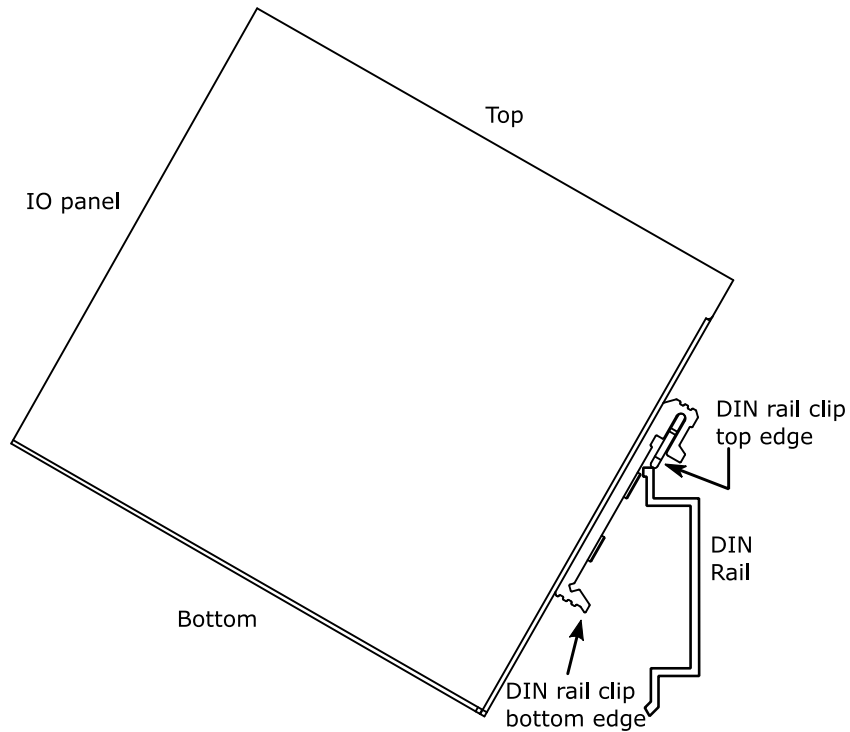

- Confirm the mount plate has indeed clipped onto the DIN rail for proper fit to complete the installation.

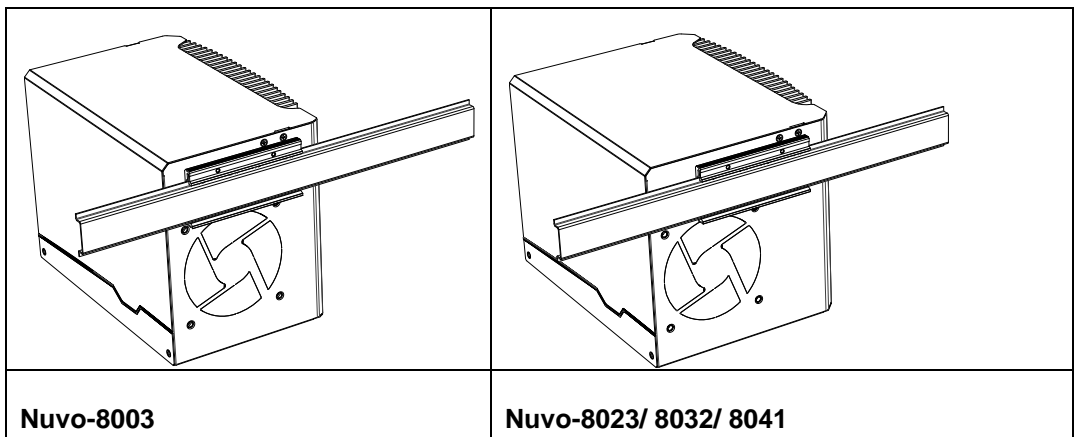

### 3.6 Powering On the System

There are three methods to power on the system

- Pressing the power button
- Sending a LAN packet via Ethernet (Wake-on-LAN)

#### 3.6.1 Powering On Using the Power Button

This is the simplest way to turn on your system. The power button is a non-latched switch and behaves as the ATX-mode on/off control. With DC power connected, pushing the power button will turn on the system and the PWR LED indicator will light up. Pushing the button when system is on will turn off the system. If your operating system supports ATX power mode (i.e. Microsoft Windows or Linux), pushing the power button while the system is in operation will result in a pre-defined system behavior, such as shutdown or hibernation.

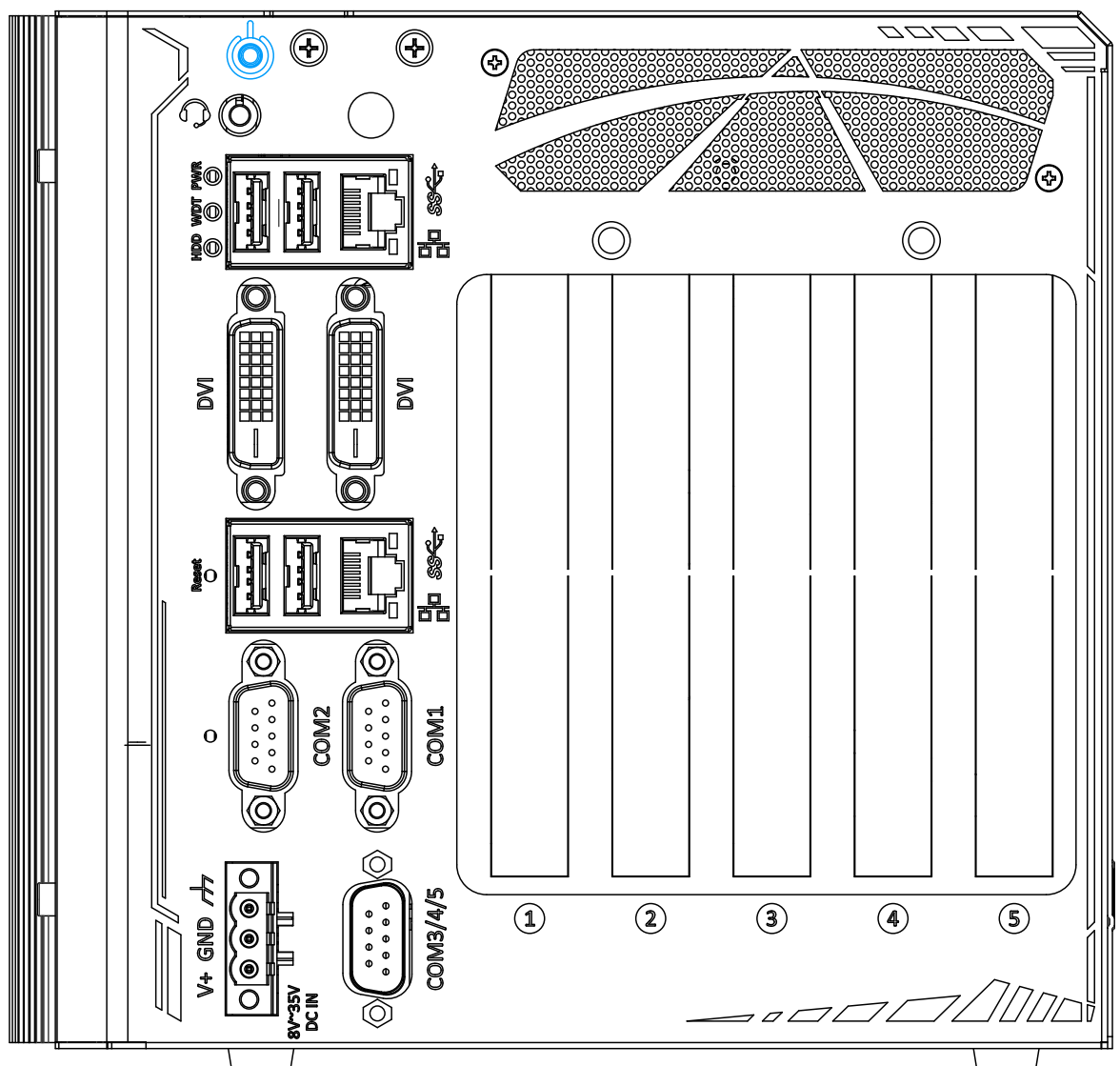

### 3.6.2 Powering On Using Wake-on-LAN

Wake-on-LAN (WOL) is a mechanism to wake up a computer system from a S5 (system off with standby power) state via issuing a magic packet. The system's Wake-on-LAN compatible GbE port is shown below.

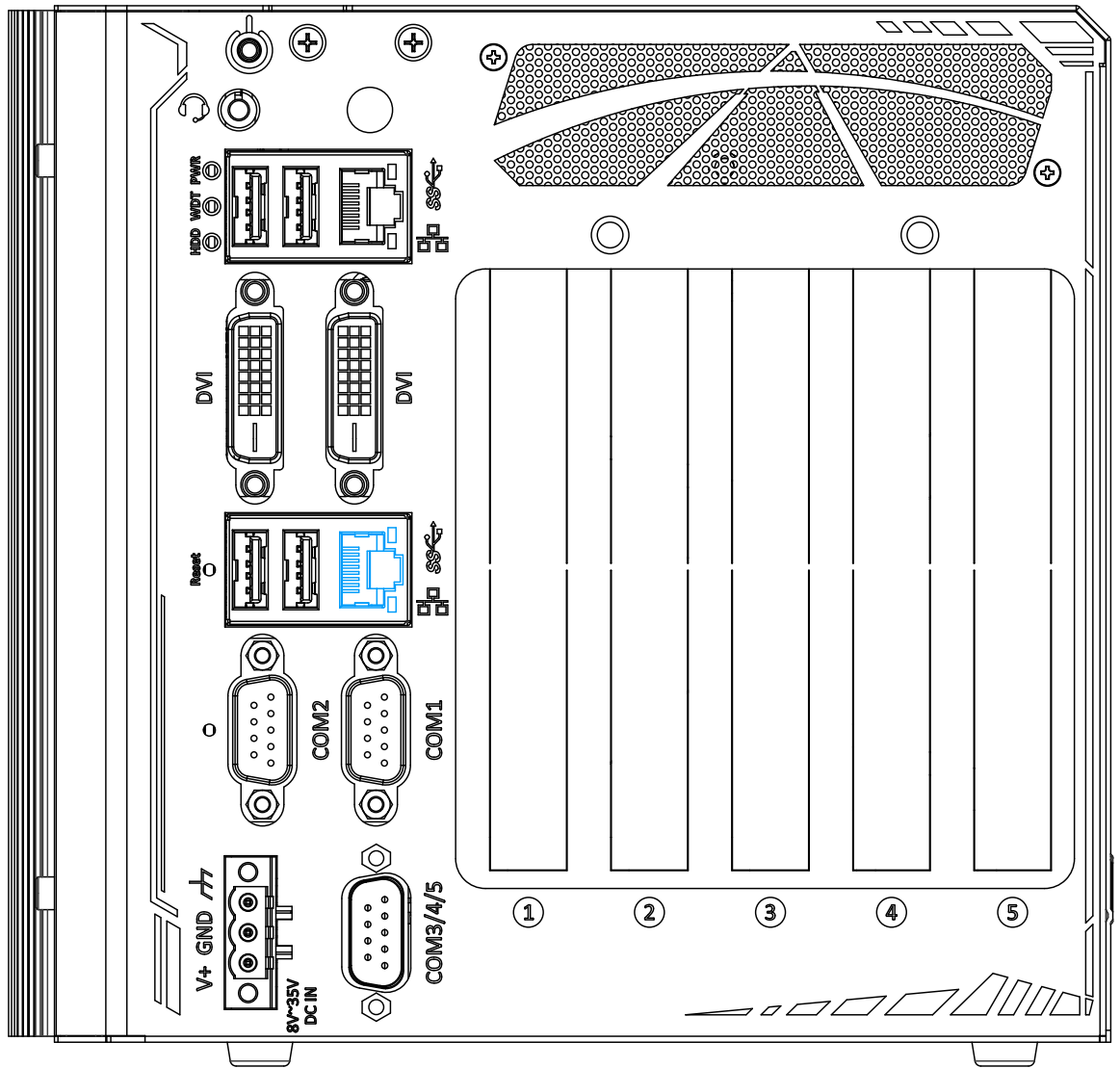

 **NOTE**

*Please make sure the Intel chipset and Ethernet driver has been properly installed prior to setting up WOL function.*

To enable WOL function, please set up WOL settings in the BIOS and in the operating system by follow the steps described below.

1. When the system boots up, press F2 to enter BIOS setup utility.
2. Go to the **[Power]>[Wake On LAN]** and set it to **[Enabled]**.
3. Press F10 to **"Save changes and exit BIOS"** and allow the system boot into the operating

- system.
- Once booted into the Windows system, press “**Windows key + E**”, right-click on “**Network>Properties>Change adapter settings**”. Locate and double-click on the adapter Intel® I219 Gigabit Network Connection, click on **Configure...**
  - Click on the **Power Management** tab and check the following options. Click on OK when done.

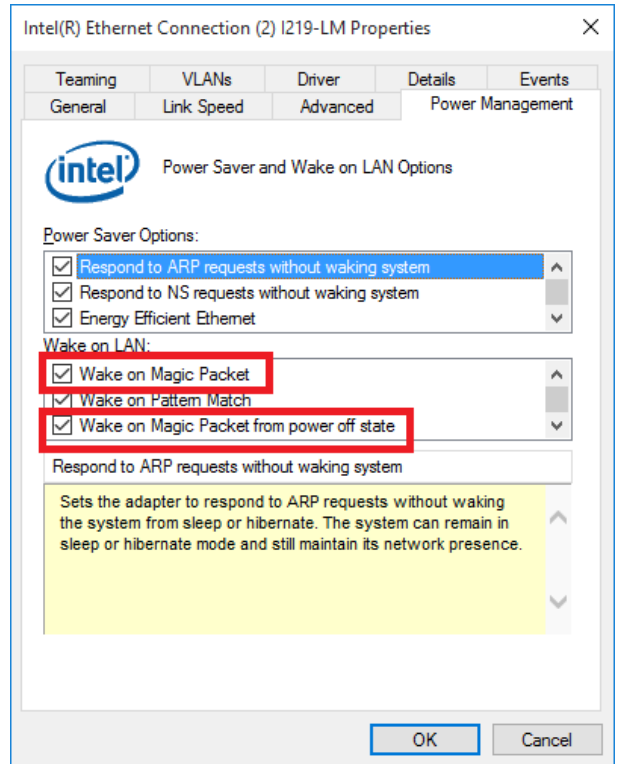

### Magic Packet

The magic packet is a broadcast frame containing anywhere within its

payload 6 bytes of all 255 (FF FF FF FF FF FF in hexadecimal), followed by sixteen repetitions of the target computer's 48-bit MAC address.

For example, NIC's 48-bit MAC

Address is 78h D0h 04h 0Ah 0Bh 0Ch

DESTINATION SOURCE MISC

FF FF FF FF FF FF

78 D0 04 0A 0B 0C	78 D0 04 0A 0B 0C
78 D0 04 0A 0B 0C	78 D0 04 0A 0B 0C
78 D0 04 0A 0B 0C	78 D0 04 0A 0B 0C
78 D0 04 0A 0B 0C	78 D0 04 0A 0B 0C
78 D0 04 0A 0B 0C	78 D0 04 0A 0B 0C
78 D0 04 0A 0B 0C	78 D0 04 0A 0B 0C
78 D0 04 0A 0B 0C	78 D0 04 0A 0B 0C
78 D0 04 0A 0B 0C	78 D0 04 0A 0B 0C
78 D0 04 0A 0B 0C	78 D0 04 0A 0B 0C
78 D0 04 0A 0B 0C	78 D0 04 0A 0B 0C

MISC    CRC

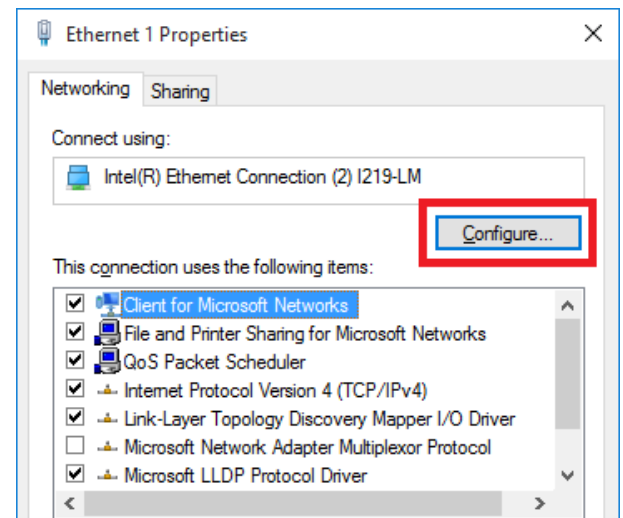

There are some free tools available on Internet that can be used to send a magic packet.

Please refer to the following link to understand more about [Magic Packet](#).



### 3.6.3 Configure your Windows system

When applying ignition power control to your system, please make sure you've configured your Windows system to initiate a shutdown process when pressing the power button. By default, Windows 7/ 8/ 10 goes to sleep (S3) mode when power button is pressed. As sleep (S3) is not a complete shutdown behavior, the ignition control function does not recognize the finish of a normal shut down process and thus users will encounter a system hard-off (power cut-off after 10 minutes). Please configure "When I press the power button" to "Shut down" in your Windows system settings.

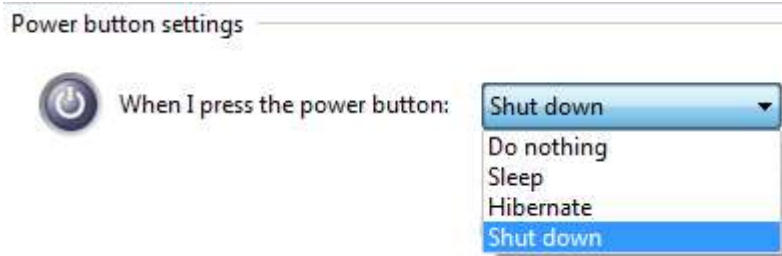

# 4 System Configuration

## 4.1 BIOS Settings

The system is shipped with factory-default BIOS settings meticulously programmed for optimum performance and compatibility. In this section, we'll illustrate some of BIOS settings you may need to modify. Please always make sure you understand the effect of change before you proceed with any modification. If you are unsure of the function you are changing, it is recommended to change one setting at a time to see its effect(s).

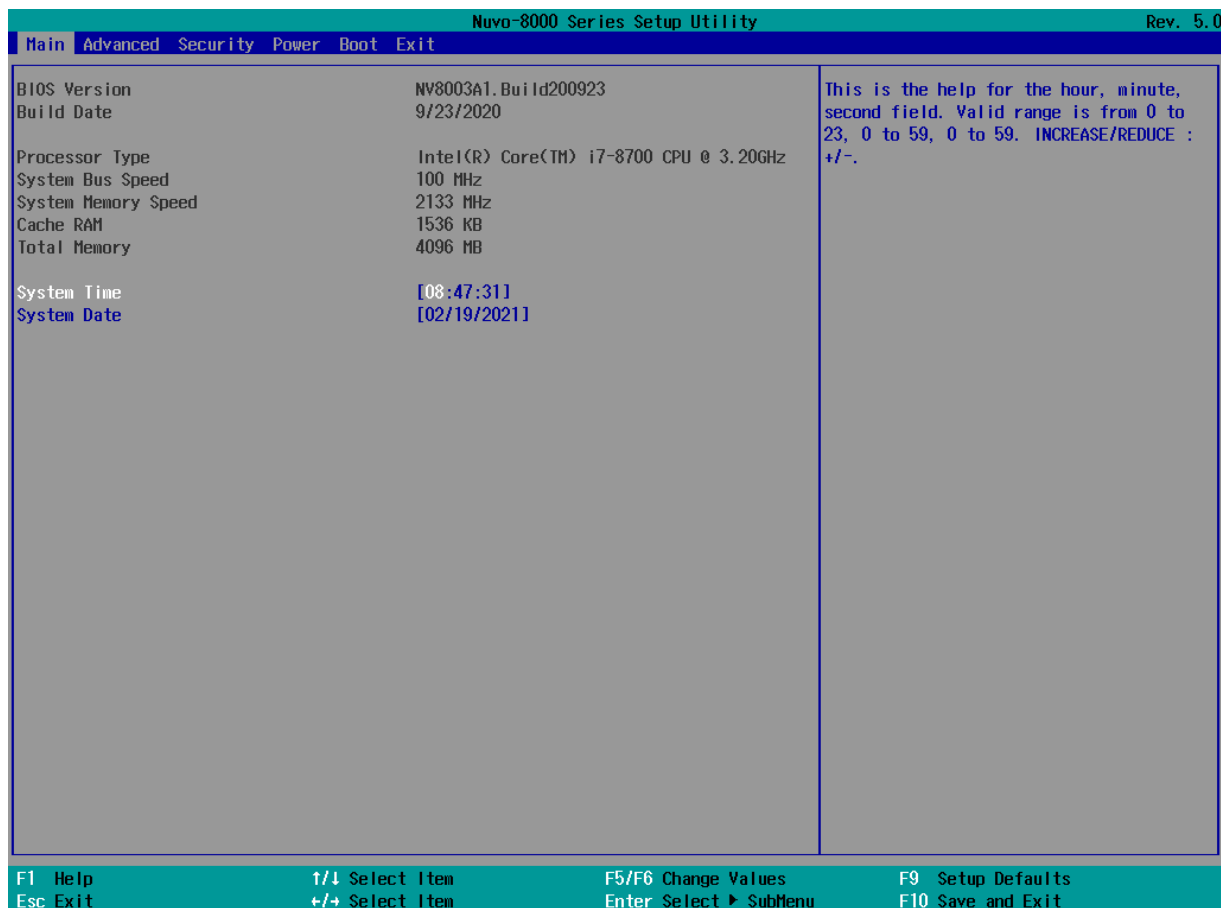

### NOTE

*Not all BIOS settings will be discussed in this section. If a particular setting/ function you are after requires specific BIOS settings but is not discussed in this section, please contact Neousys Technical Support staff.*

### 4.1.1 COM Port Configuration

The system's [COM1/ COM2](#) ports support RS-232 (full-duplex), RS-422 (full-duplex) and RS-485 (half-duplex) mode. You can set the COM1 operating mode via BIOS settings. Another option in BIOS called “*Slew Rate*” defines how sharp the rising/falling edge is for the output signal of COM1. For long-distance RS-422/ 485 transmission, you may set the “*Slew Rate*” option as “High” to improve signal quality. For RS-422/ 485 communication, the “*RS-422/ 485 Termination*” option determines whether to enable/disable internal termination of RS-422/ 485 transceiver according to your wiring configuration (e.g. with or without external termination).

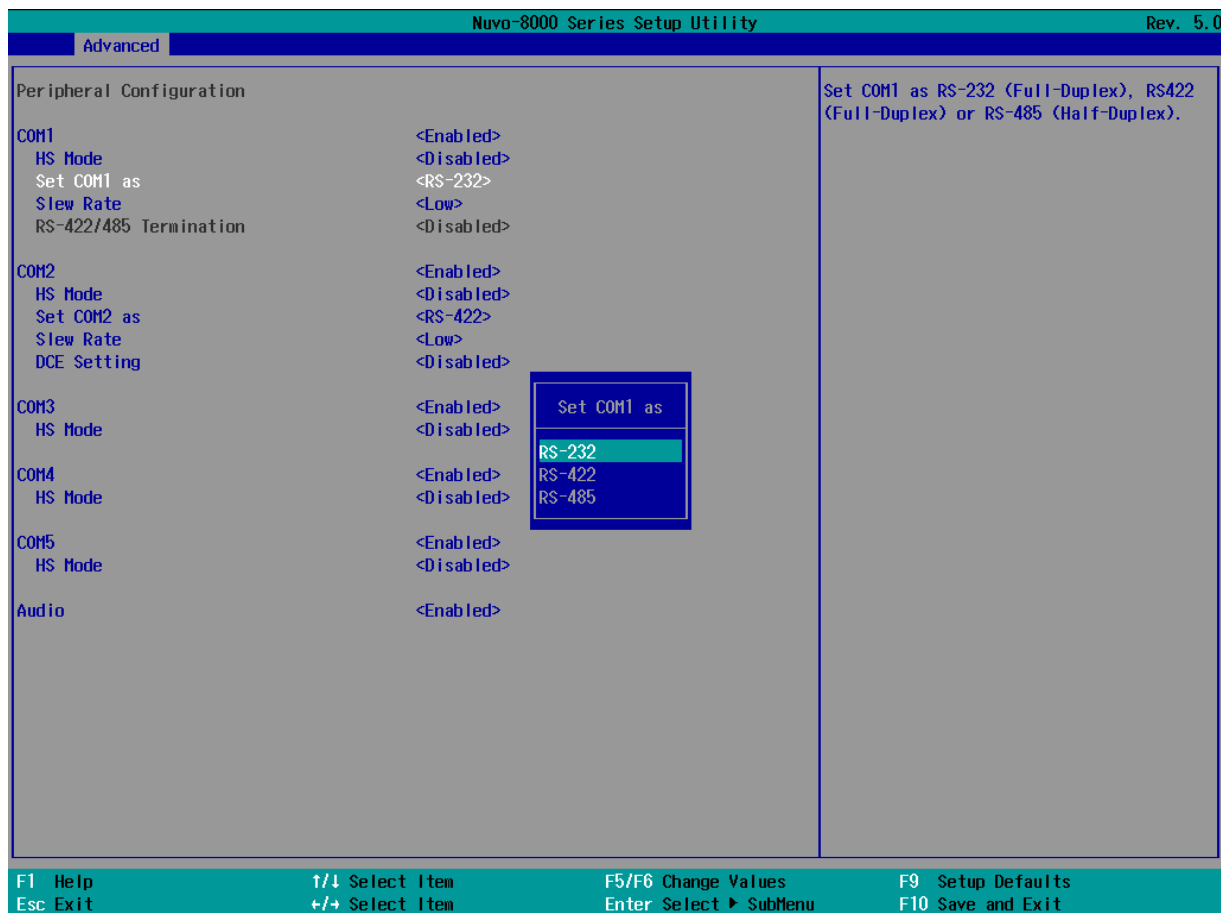

#### To set COM port operating mode:

1. Press **F2** when the system boots up to enter the BIOS setup utility.
2. Go to **[Advanced]** → **[Peripheral Configuration]**.
3. Set the **[Set COM1 Mode as]** option to the desired mode.
4. Once set, press **F10** to save setting and exit.

### 4.1.2 COM Port High Speed Mode

The high speed mode of each COM port effectively allows for the port's baud rate generator to operate at 8x the speed with an effective baud rate of 921,600 bps (115,200 x 8). Please refer to the following instructions on how to enable the high speed mode for your COM port (COM1 used as an example).

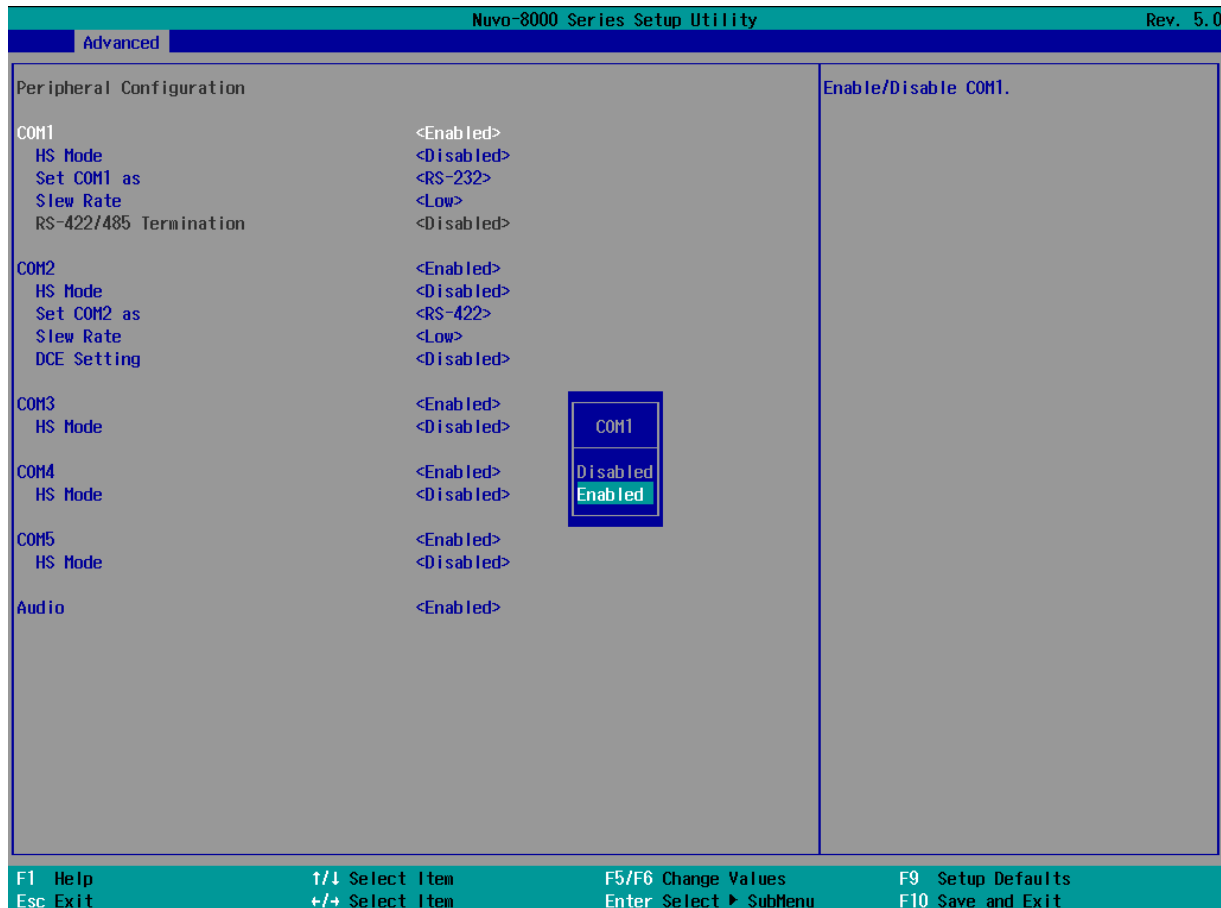

#### To set COM port high speed mode:

1. Press **F2** when the system boots up to enter the BIOS setup utility.
2. Go to **[Advanced] > [Peripheral Configuration]**.
3. Enable or set the **[Set COM1 Mode as]** option to the desired mode.
4. Highlight **[HS Mode]** and press ENTER to bring up options, highlight **[Enable]** and press ENTER.
5. Once set, press **F10** to save setting and exit.

### 4.1.3 Delay for PEG Initialization

This setting offers delay in milliseconds for PEG port initialization and PCI enumeration. By increasing the delay value, it may eliminate compatibility issue(s) with some PCIe add-on cards.

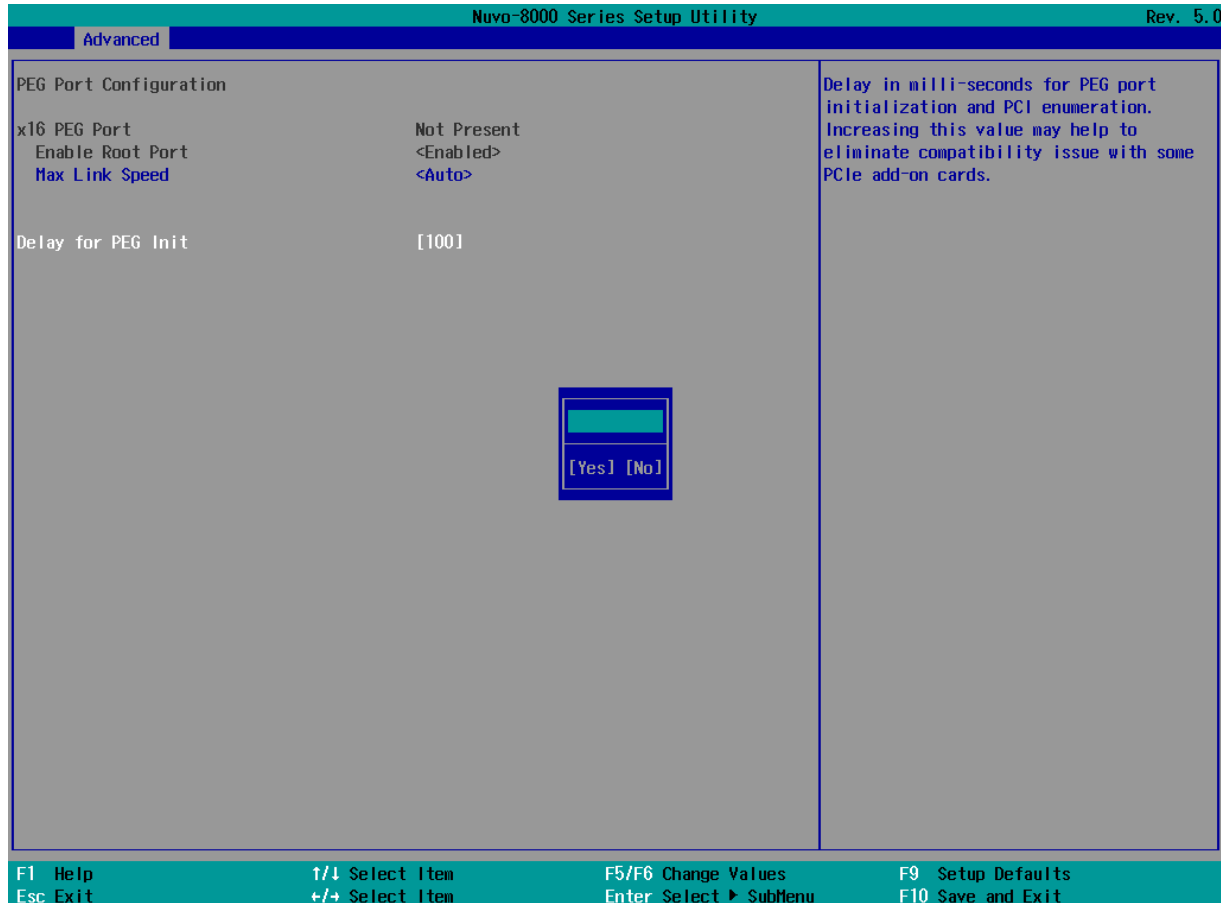

#### To set PEG delay in milliseconds:

1. When system boots up, press F2 to enter BIOS setup utility.
2. Go to **[Advanced] > [System Agent (SA) Configuration] > [PEG Port Configuration] > [Delay for PEG Init]** and press ENTER.
3. A small window appears and you may enter a maximum delay value of up to 30,000ms.
4. When done, press F10 to "Exit Saving Changes"

#### 4.1.4 SATA and mSATA Configuration

The SATA and mSATA port of your system can be Enabled or Disabled through the BIOS.



To enable or disable the SATA controller:

1. When system boots up, press F2 to enter BIOS setup utility.
2. Go to **[Advanced] > [SATA Configuration]**.
3. Highlight the SATA Controller(s) or mSATA, press ENTER to bring up Enabled/ Disabled setting options. Scroll to and highlight the setting you wish to set and press ENTER.
4. Press F10 to "Exit Saving Changes".

### 4.1.5 Fan Control Configuration

The fan control configuration allows users to set the fan operation mode to auto or fixed speeds operation. The auto mode configuration also offers minimum temperature setting to trigger the fan and the maximum temperature setting before the fan operates at 100% rotation speed.

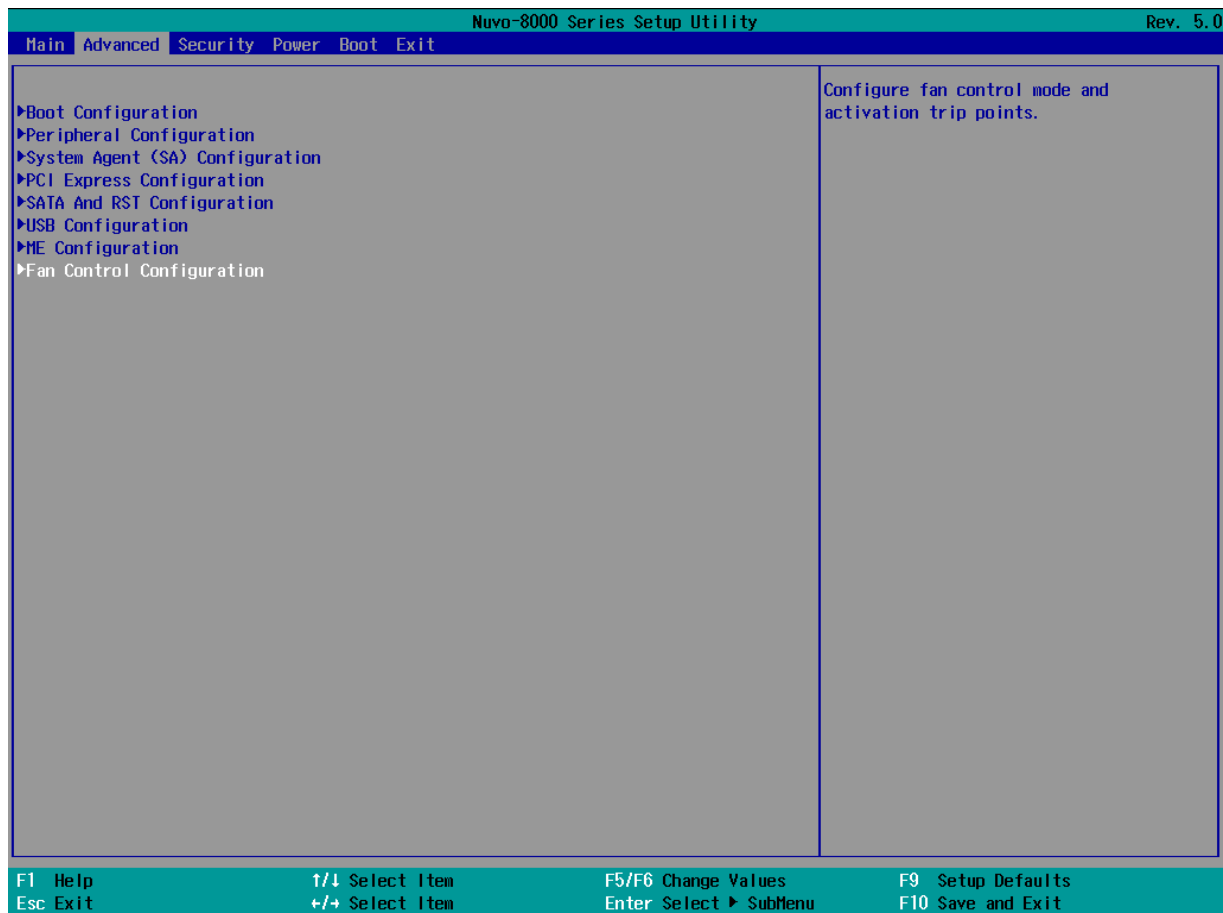

**To set Fan Control Configuration to Auto mode:**

1. When system boots up, press F2 to enter BIOS setup utility.
2. Go to **[Advanced]** > **[Fan Control Configuration]** and press ENTER.
3. To set auto fan control, highlight **[Fan Control Mode]** and press ENTER, highlight **[Auto]**

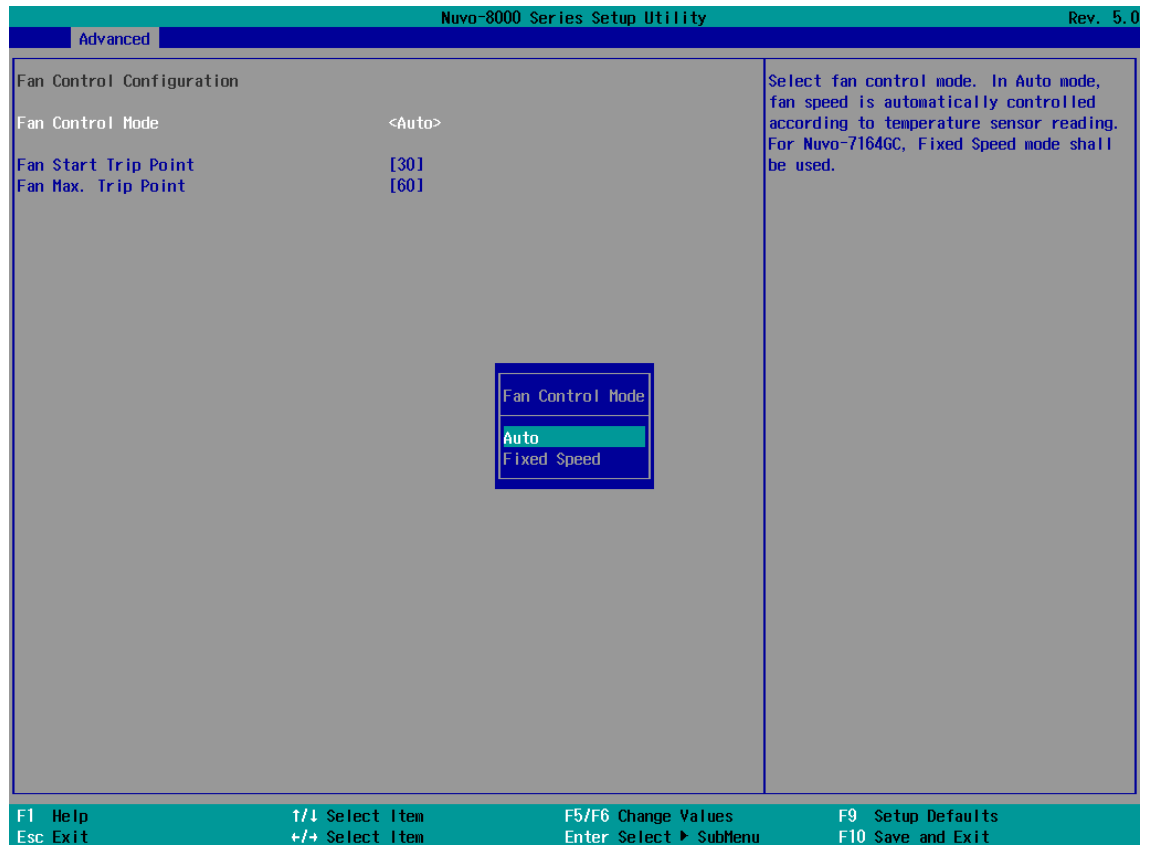



4. Use the up/ down arrow keys to highlight Fan Start Trip Point or Fan Max. Trip Point and press ENTER, a window appears and you may enter the temperature in degree Celsius.
  - **Fan Start Trip Point:** The minimum temperature which the fan being to operate
  - **Fan Max. Trip Point:** The maximum temperature where the fan begins to operate at 100% rotation speed



5. When done, press F10 to "Exit Saving Changes".

**To set Fan Control Configuration to Fixed Speed mode:**

1. When system boots up, press F2 to enter BIOS setup utility.
2. Go to **[Advanced]** > **[Fan Control Configuration]** and press ENTER.
3. To set auto fan control, highlight **[Fan Control Mode]** and press ENTER, highlight **[Fixed Speed]**.

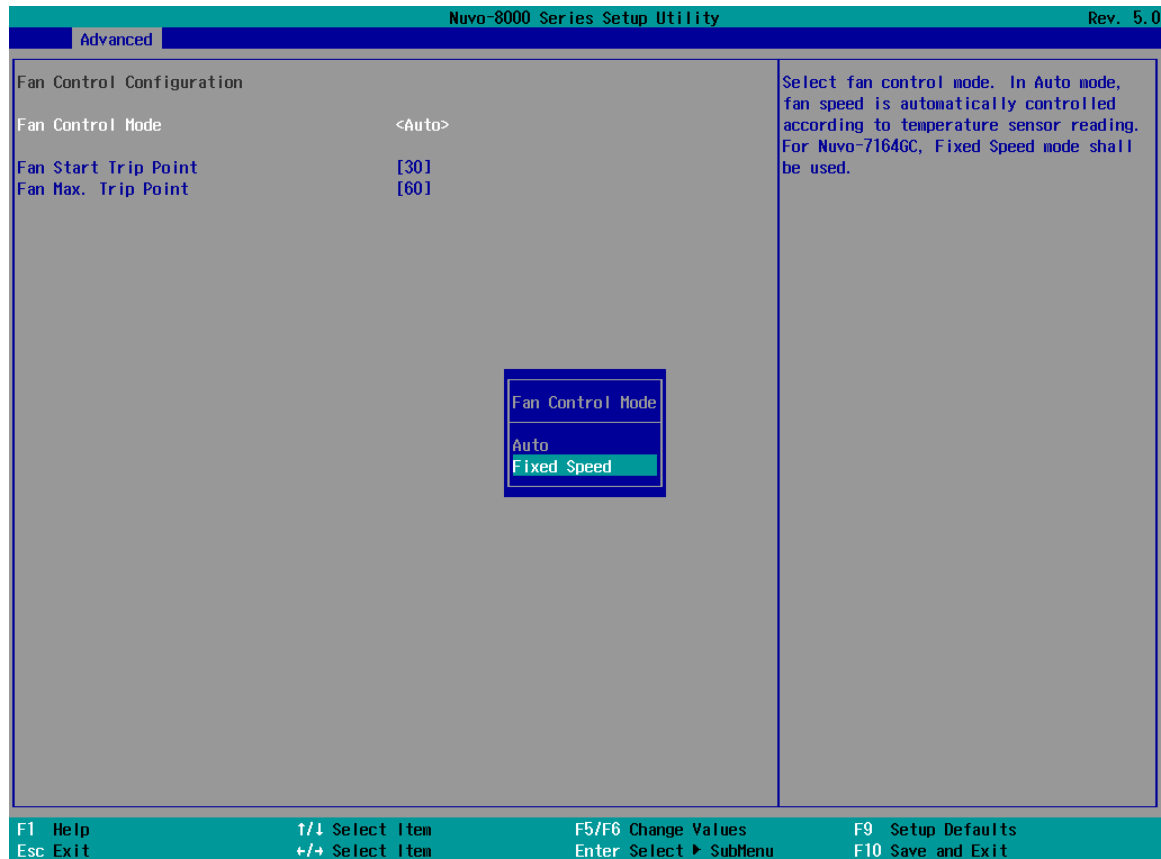

4. Highlight [**Fan Speed**] and press ENTER.
5. A window appears and you may use the up/ down arrow keys to select between 20~100% as your fixed fan rotation speed.

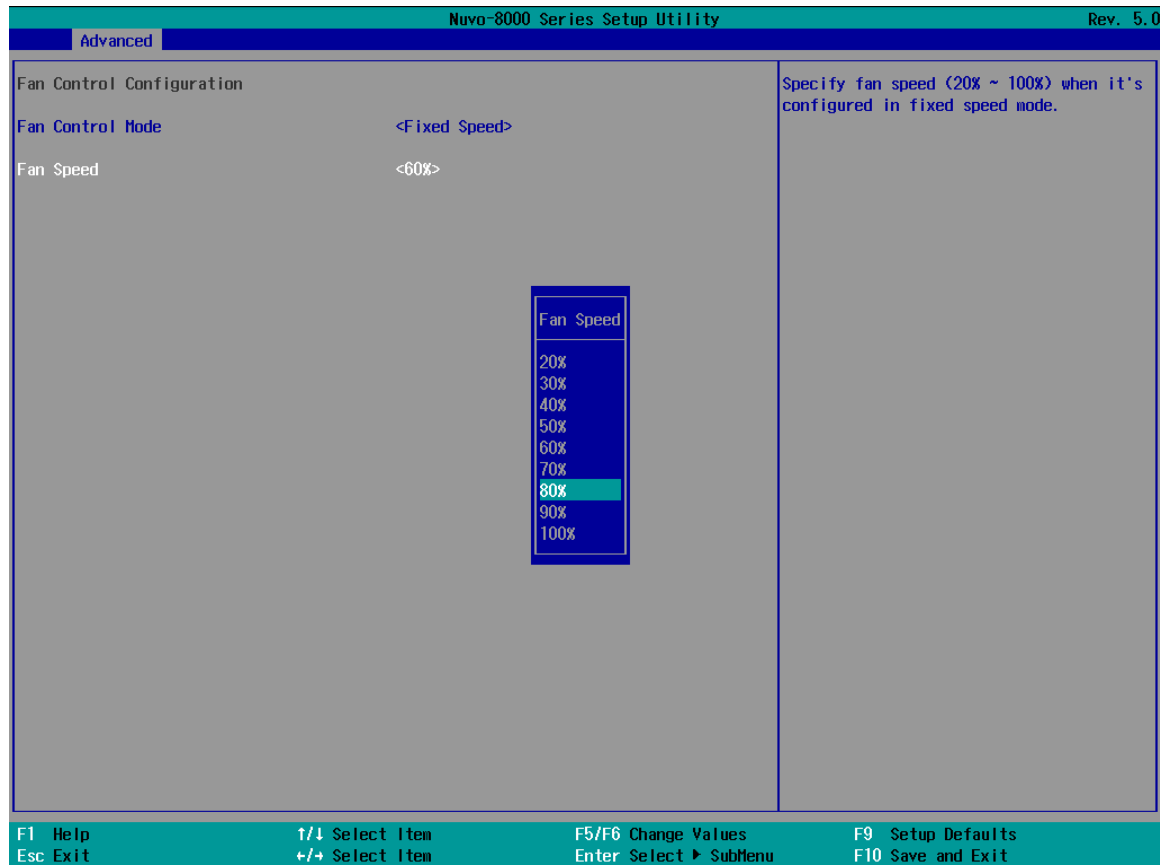

6. When done, press F10 to "Exit Saving Changes".

### 4.1.6 Power On After Power Failure Option

This option defines the behavior of System series when DC power is supplied.

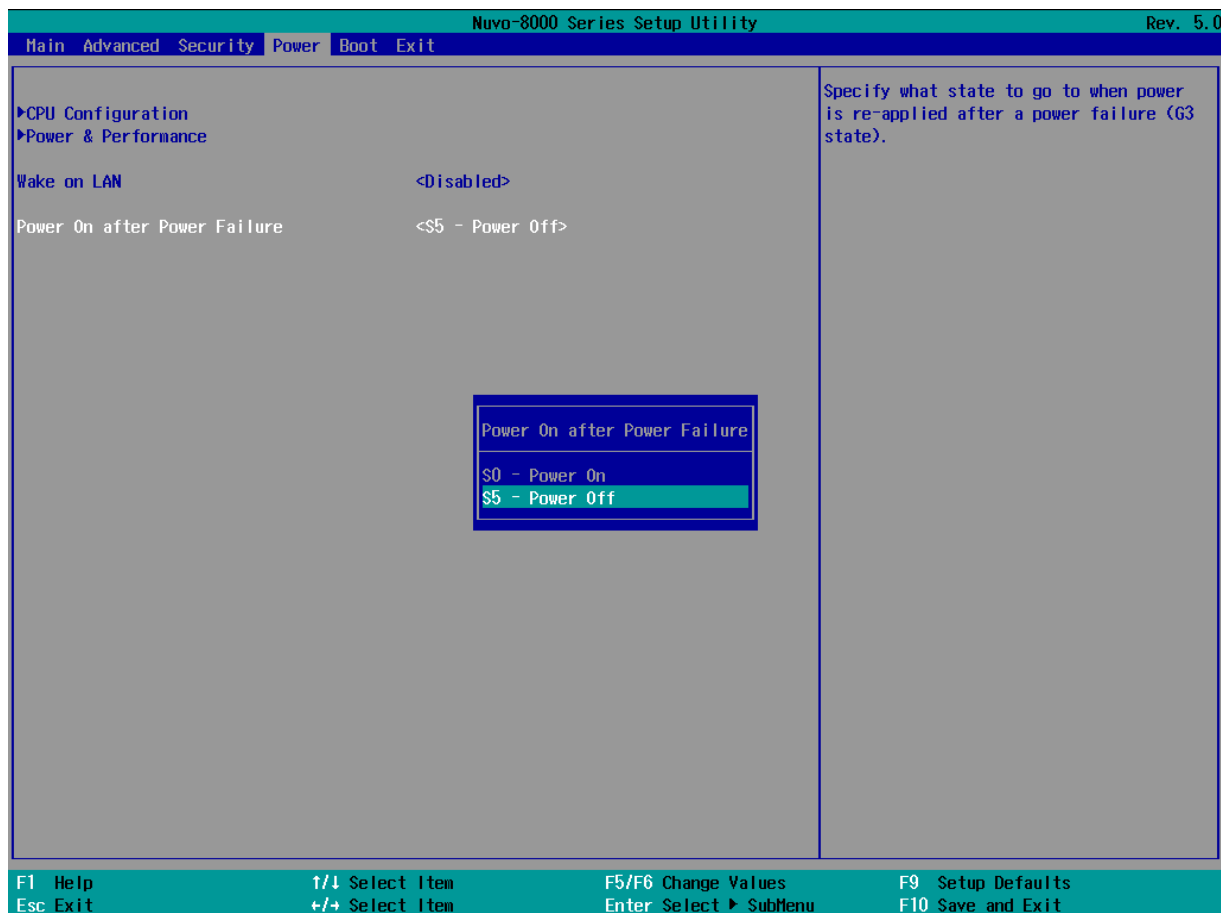

Value	Description
S0 – Power On	System is powered on when DC power is supplied.
S5 – Power Off	System is kept in off state when DC power is supplied.

To set “Power On after Power Failure” option:

1. When system boots up, press F2 to enter BIOS setup utility.
2. Go to **[Power] > [Power On after Power Failure]**.
3. Scroll down to highlight **[Power On after Power Failure]**, press ENTER to bring up setting options, S0 – Power On or S5 – Power Off, and press ENTER to select the setting.
4. Press F10 to “Exit Saving Changes”.

### 4.1.7 Power & Performance (CPU SKU Power Configuration)

The system supports Intel 9<sup>th</sup>-Gen Coffee Lake LGA1151 CPUs. A unique feature, “**SKU Power Config**” is implemented in BIOS to allow users to specify user-defined SKU power limit.

Although the system is designed to have best thermal performance with CPUs of 35W TDP, you can install a 65W CPU and limit its SKU power (to 35W) to obtain more computing power.

This feature gives you the flexibility of CPU selection and great balance between computing power and operating temperature range.

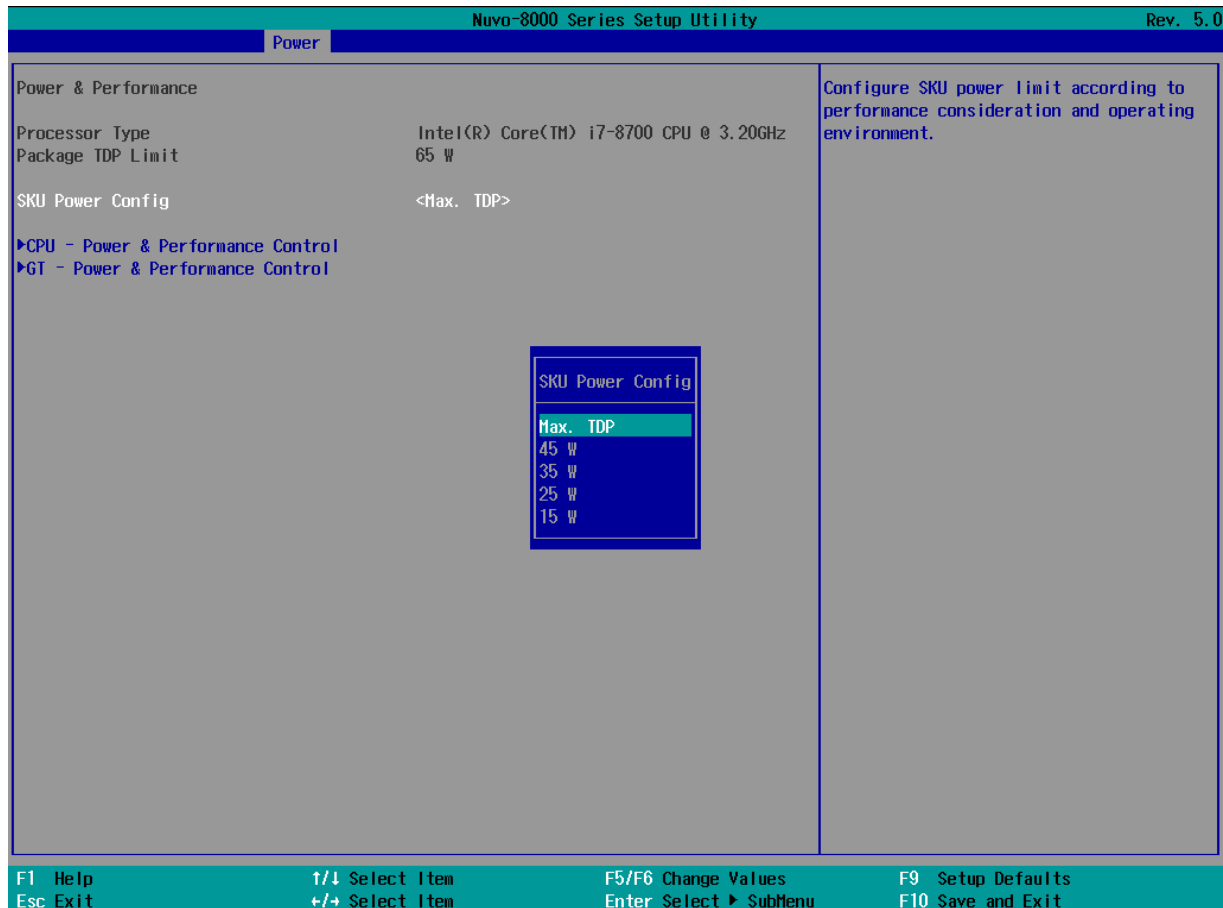

To configure the CPU SKU power limit:

1. When the system boots up, press F2 to enter BIOS setup utility.
2. Go to **[Power]** → **[Power & Performance]**.
3. Select a proper value of SKU power limit for **[SKU Power Config]** option.
4. Press F10 to "Exit Saving Changes".

### 4.1.8 Wake on LAN Option

Wake-on-LAN (WOL) is a mechanism which allows you to turn on your System series via Ethernet connection. To utilize Wake-on-LAN function, you have to enable this option first in BIOS settings. Please refer "[Powering On Using Wake-on-LAN](#)" to set up the system.



To enable/ disable “Wake on LAN” option:

1. When system boots up, press F2 to enter BIOS setup utility.
2. Go to **[Power]> [Wake on LAN]**.
3. Press ENTER to bring up setting options, scroll to the setting you desire and press ENTER to set.
4. Press F10 to “Exit Saving Changes.”

### 4.1.9 Boot Menu

The Boot menu in BIOS allows you to specify the system’s boot characteristics by setting bootable device components (boot media) and method. Or, you may press F12 upon system start up and select a device you wish boot from.

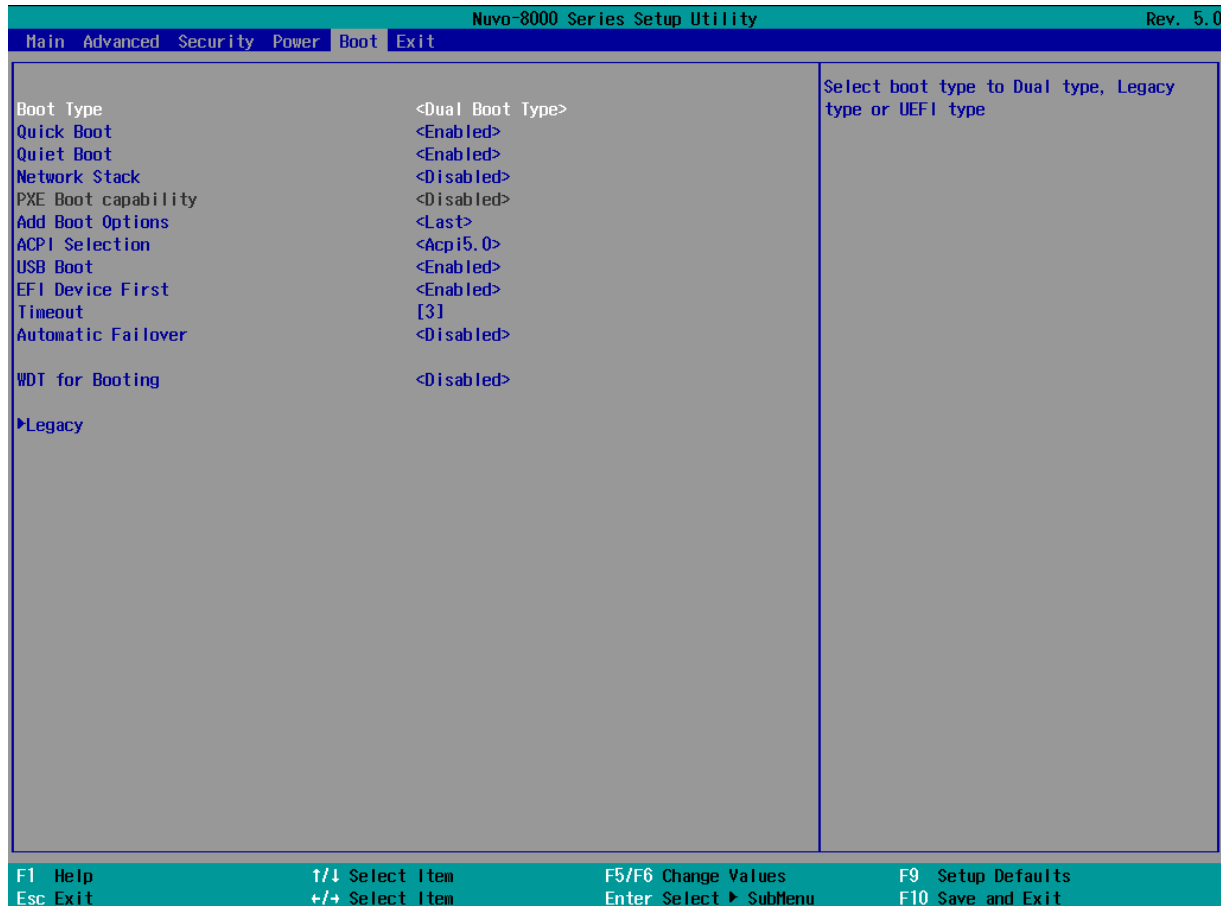

Value	Option	Description
<a href="#">Boot Type</a>	Dual Boot Type	Both legacy and EFI boot media listed are approved as boot media.
	Legacy Boot Type	Only legacy boot media listed are approved as boot media.
	UEFI Boot Type	Only legacy boot media listed are approved as boot media.
Quick Boot	Enabled	The system starts up faster because BIOS skips various hardware function tests
	Disabled	The system starts up slower because BIOS goes through various hardware functions tests
Network Stack	Enabled	The system is available for network access using UEFI.
	Disabled	The system is not available for network access

		using UEFI.
PXE Boot capability	Disabled	Only UEFI Network Stack is supported: Preboot eXecution Environment (PXE) is not supported
	Enabled	By enabling the PXE boot, one can choose to boot via <b>I219 Only/ I210 Only</b> or <b>All NICs</b> .
Add Boot Options	First	Newly detected boot media are placed at the top of the boot order.
	Last	Newly detected boot media are placed at the bottom of the boot order.
ACPI Selection	1.0B/ 3.0/ 4.0/ 5.0/ 6.0	Advanced Configuration and Power Interface allows the operating system to control system power management
USB Boot	Enabled	Allow boot from bootable USB devices.
	Disabled	Does not allow boot from bootable USB devices
EFI Device First	Enabled	Set to boot bootable EFI media first.
	Disabled	Will not boot bootable EFI media first.
Timeout	1, 2, 3, etc (in seconds)	Boot delay time in seconds to give the user time to activate the hotkey to access the BIOS
<a href="#">WDT for booting</a>	Disabled, 1, 3, 5, 10 (minutes)	WDT ensures a successful system boot by specifying a timeout value



#### 4.1.10 Boot Type (Legacy/ UEFI)

The system supports both Legacy and Unified Extensible Firmware Interface (UEFI) boot modes. UEFI is a specification proposed by Intel to define a software interface between operating system and platform firmware. Most modern operating systems, such as Windows 7/8/10 and Linux support both Legacy and UEFI boot modes. The Legacy boot mode uses MBR partition for disk and VBIOS for video initialization, the UEFI boot mode uses GPT partition which supports greater than 2TB partition size and GOP driver for faster video initialization.

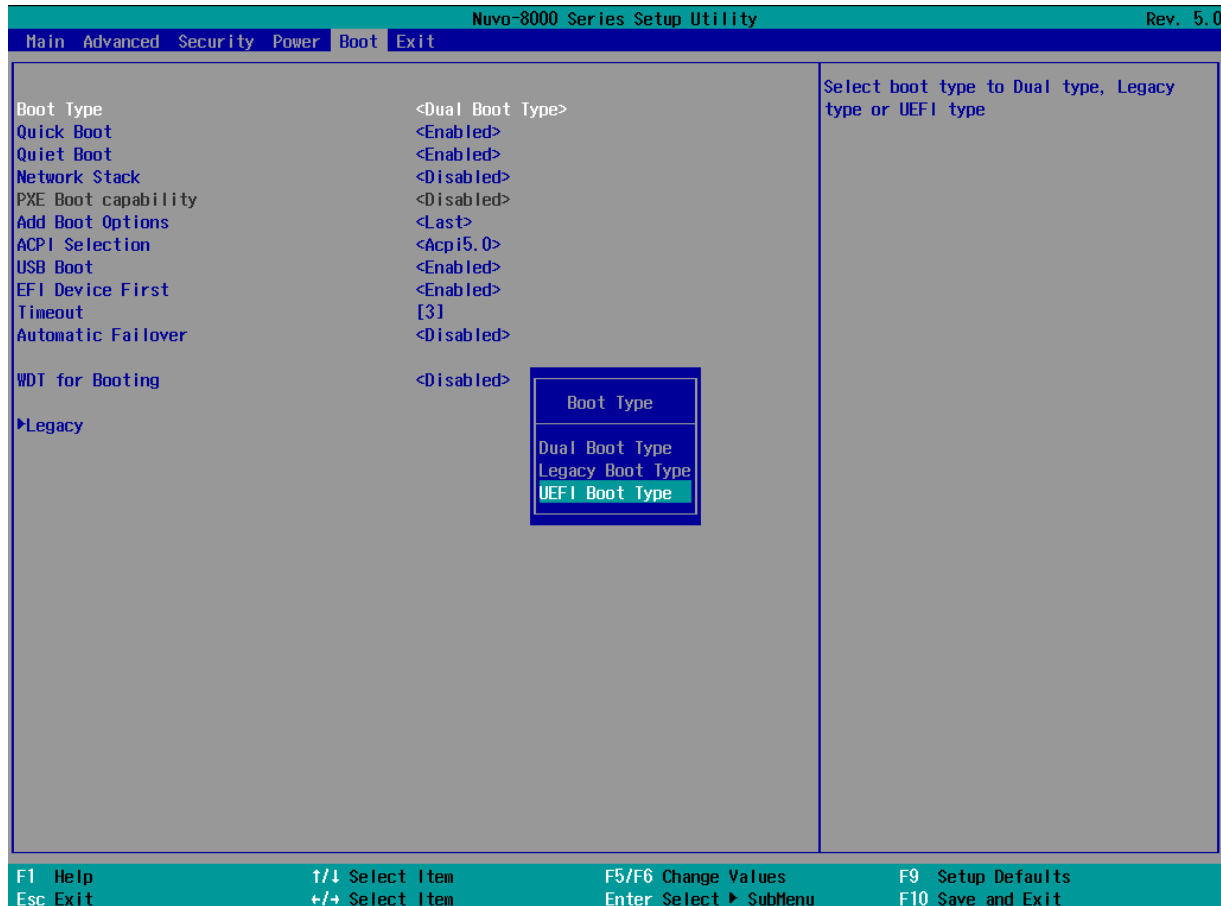

 **NOTE**

*If you choose Legacy mode, you will not be able to create disk partitions greater than 2TB or use TPM 2.0 function.*

To configure Boot Type:

1. When system boots up, press F2 to enter BIOS setup utility.
2. Go to **[Boot]>[Boot Type]**, press Enter to bring up options, Dual Boot (Legacy+UEFI), Legacy Boot Type, UEFI Boot Type.
3. Highlight your selection and press Enter.
4. Press F10 to “Exit Saving Changes”.

### 4.1.11 Position New Boot Device

The “Add Boot Options” allow you to determine whether a newly added device (eg. USB flash disk) is to boot as the first device to boot or the last in the boot sequence.

To set the newly-installed boot device as the first or last boot device:

1. Press **F2** when the system boots up to enter the BIOS setup utility.
2. Go to **[Boot] > [Add Boot Options]** menu.
3. Select **[First]** or **[Last]** for your newly-added boot device and press ENTER.

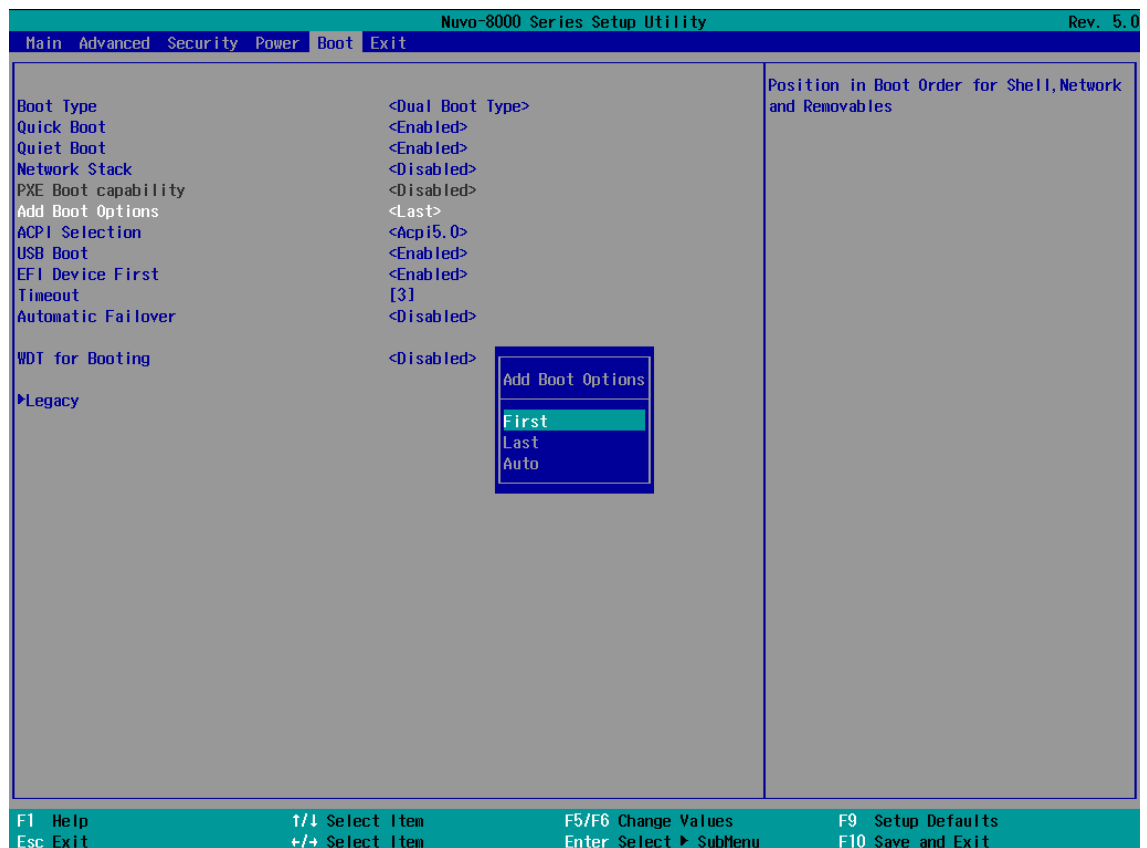

4. Once set, press **F10** to save setting and exit.

### 4.1.12 Watchdog Timer for Booting

The watchdog timer secures the boot process by means of a timer. Once the timer expires, a reset command is issued to initiate another booting process. There are two options in BIOS menu, “*Automatically after POST*” and “*Manually after Entering OS*”. When “*Automatically after POST*” is selected, the BIOS automatically stops the watchdog timer after POST (Power-On Self Test) OK. When “*Manually after Entering OS*” is selected, the user must stop the watchdog timer once booted into the OS. This guarantees the system can always boot into the OS, otherwise another booting process will be initiated. For information about programming watchdog timer, please refer to [Watchdog Timer & Isolated DIO](#).

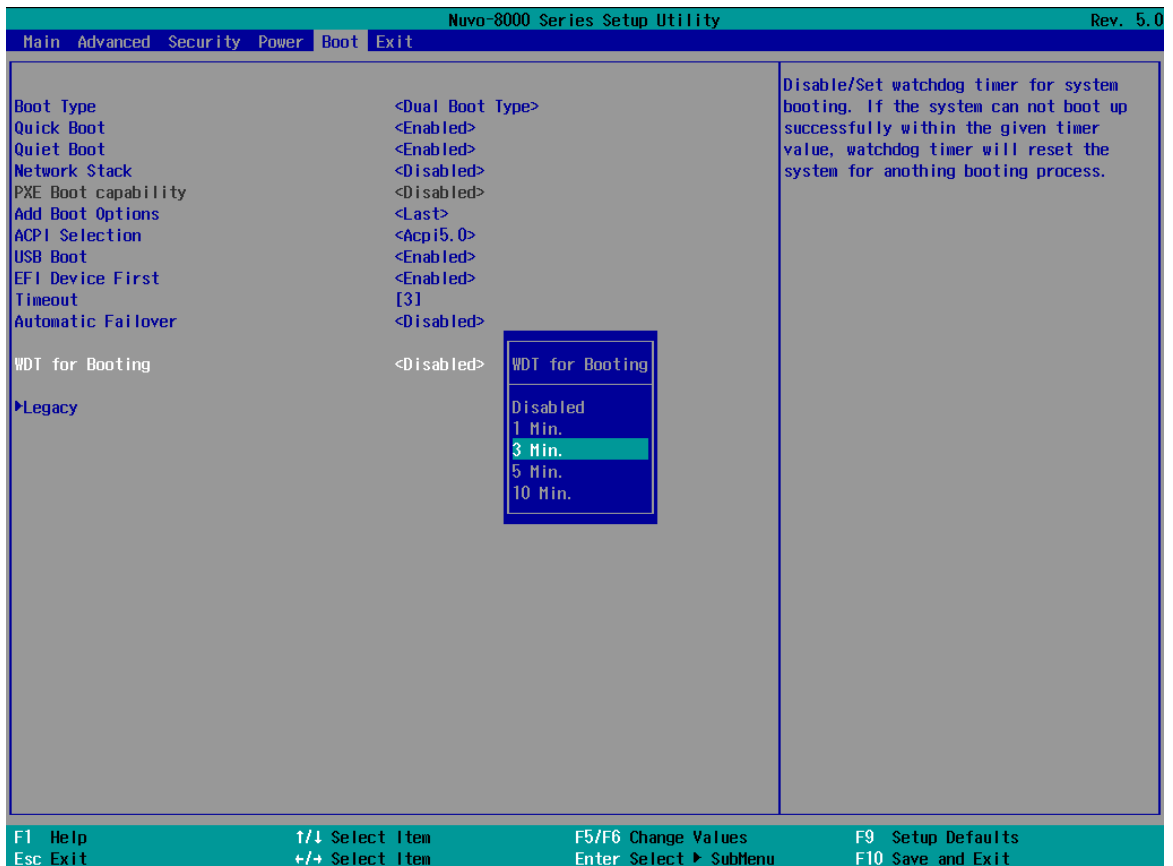

To set the watchdog timer for boot in BIOS:

1. When system boots up, press F2 to enter BIOS setup utility.
2. Go to **[Boot]** menu.
3. Disable or select timeout value for **[WDT for Booting]** option.
4. Once you give a timeout value, the **[WDT Stop Option]** option appears. You can select “*Automatically after POST*” or “*Manually after Entering OS*”.
5. Press F10 to “Exit Saving Changes”.

#### 4.1.13 Legacy/ UEFI Boot Device

When you wish to set a designated boot device, you may set it as the first device to boot in Legacy or UEFI Boot Device setting. Or if you wish to manually select a boot device, you may do so by pressing F12 when the system boots up.

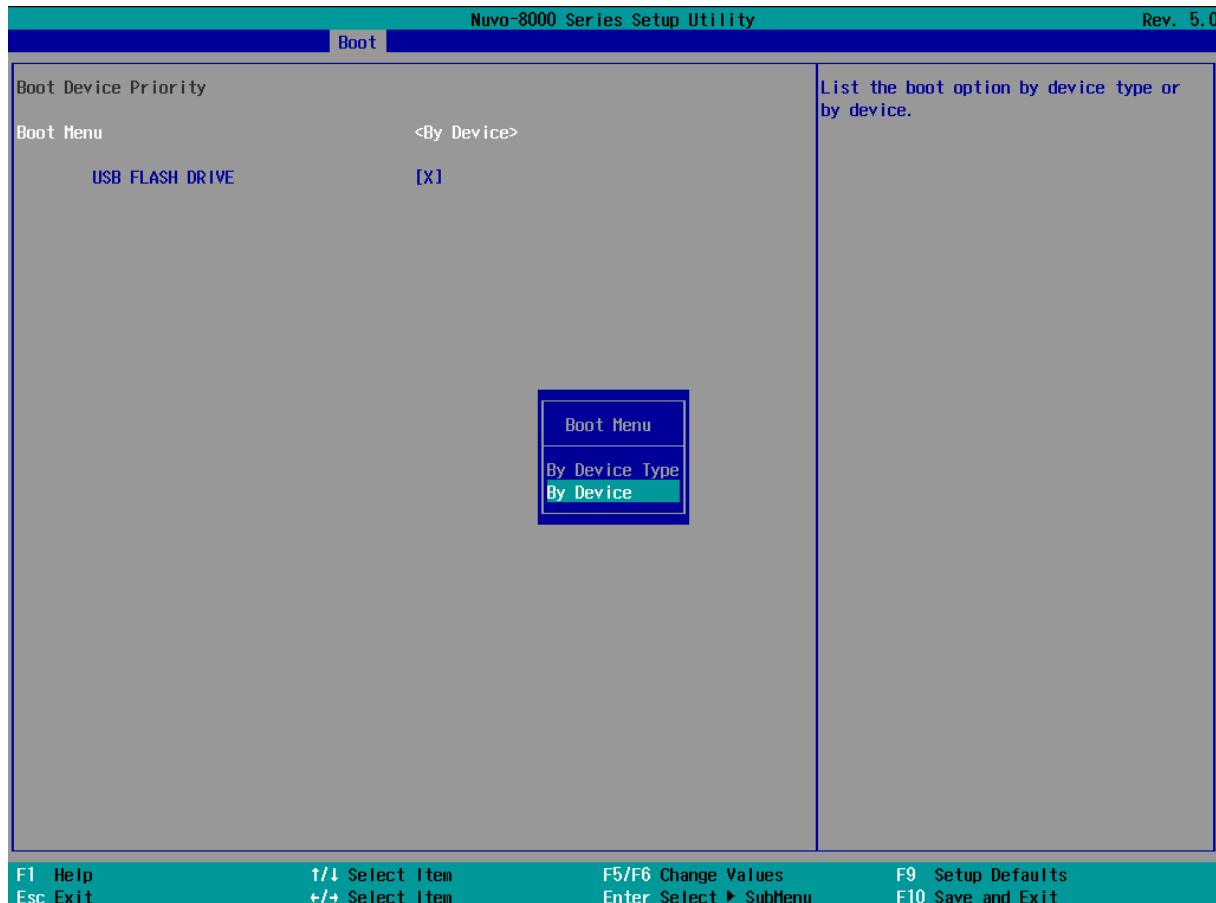

To set boot order for devices in UEFI Boot Device:

1. When system boots up, press F2 to enter BIOS setup utility
2. Go to **[Boot] > [UEFI Boot Device]**
3. Highlight the device you wish to make boot order changes to and press F5/ F6 or +/- to change device boot order.

To select boot order for devices in Legacy Boot Device:

1. When system boots up, press F2 to enter BIOS setup utility
2. Go to **[Boot] > [Legacy Boot Device]**, you can choose the type of device to list by selecting "By Device or By Device Type".
3. Highlight the device you wish to make boot order changes to and press F5/ F6 or +/- to change device boot order.

## 4.2 AMT Configuration

Intel® AMT (Active Management Technology) is a hardware-based technology for remotely managing target PCs via Ethernet connection. The system supports AMT function via its Ethernet port implemented with Intel I219-LM. Prior to using the AMT function to remotely control the system, you need to configure AMT password and network settings.

1. Connect an Ethernet cable to the I219-LM Ethernet port.

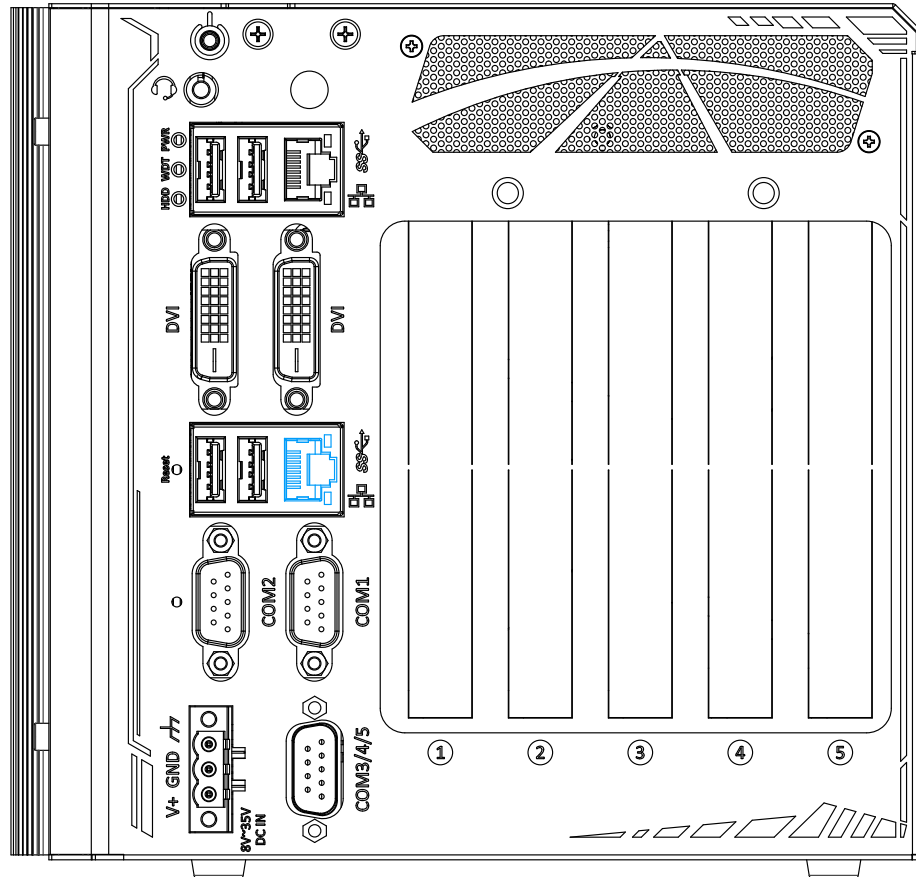

- When the system boots up, press F10 to enter the MEBx configuration menu.

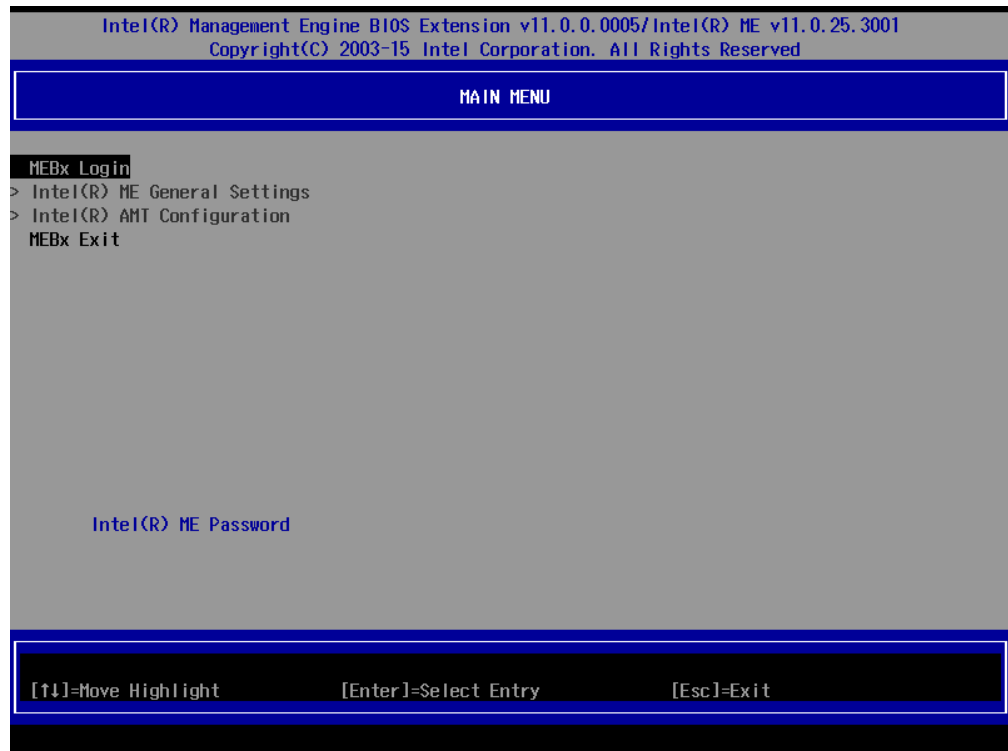

- Highlight MEBx Login and press Enter, a prompt will appear asking for password. The default password is “admin”. For further MEBx configuration details, please refer to [Intel® MEBX User Guide](#).

## 5 OS Support and Driver Installation

### 5.1 Operating System Compatibility

The system supports most operating system developed for Intel® x86 architecture. The following list contains the operating systems which have been tested by Neosys Technology.

- Microsoft Window 10 (x64)
- Fedora 29\*\*
- Ubuntu 16.04.5 LTS\*\* & Ubuntu18.04.0 LTS\*\*



#### NOTE

*For other Linux OS, Linux kernel should upgrade to 4.15.18.*

*\*For Linux system, user may need to manually compile and install the driver for Intel graphics or I210 GbE controller if the driver is not embedded in kernel. You can visit Intel website for further information.*

*\*\*For distributions, graphics driver and RAID function may not be completely implemented in its kernel. You may encounter restrictions when using these features, such as triple independent display and RAID. For optimum operation, it is the users' responsibility to manually check for new drivers and upgrades!*

Neosys may remove or update operating system compatibility without prior notice. Please contact us if your operating system of choice is not on the list.

## 5.2 Driver Installation

The system comes with a “Drivers & Utilities” DVD that offers “one-click” driver installation process. It automatically detects your Windows operating system and installs all necessary drivers for you system with a single click.

### 5.2.1 Install Drivers Automatically

The system comes with a “Drivers & Utilities” DVD that offers “one-click” driver installation process. It automatically detects your Windows operating system and installs all necessary drivers for you system with a single click.

To install drivers automatically, please refer to the following procedures.

1. Insert the “Drivers & Utilities” DVD into a USB DVD-drive connect to your system. A setup utility launches and the following dialog appears.



Click on “**Automatic Driver Installation**” and the setup utility will automatically detect your Windows operating system and install all necessary drivers. The installation process takes about 6~8 minutes depending on your Windows version. Once driver installation is done, the setup utility reboots your Windows and you may begin using your system.



## 5.2.2 Install Drivers Manually

You can also manually install each driver for the system. Please note when installing drivers manually, you need to install the drivers in the following sequence mentioned below.

### Windows 10 (x64)

The recommended driver installation sequence is

1. Chipset driver (x:\Driver\_Pool\Chipset\_10\_APL\Win\_ALL\SetupChipset.exe)
2. Graphics driver (x:\Driver\_Pool\Graphics\_SKL\_APL\Win\_7\_8\_10\_APL\_64\Setup.exe)
3. Audio driver (x:\Driver\_Pool\Audio\_ALC262\Win\_ALL\_64\Setup.exe)
4. LAN driver  
(x:\Driver\_Pool\GbE\_I210\_I350\Win\_ALL\_64\APPS\PROSETDX\Win10\_x64\DxSetup.exe)
5. ME driver (x:\Driver\_Pool\ME\_10\_Series\Win\_ALL\_AMT\SetupME.exe)

## 5.3 Driver Installation for Watchdog Timer Control

Neosys provides a driver package which contain function APIs for Watchdog Timer control function. You should install the driver package (WDT\_DIO\_Setup.exe) in prior to use these functions. Please note that you must install WDT\_DIO\_Setup\_v2.3.0.6 or later versions.

### **Windows 10 (x64)**

Please execute the driver setup program in the following directory.

x:\Driver\_Pool\WDT\_DIO\Win7\_8\_64\WDT\_DIO\_Setup\_v2.3.0.6(x64).exe

### **Windows 10 (WOW64)**

Please execute the driver setup program in the following directory.

x:\Driver\_Pool\WDT\_DIO\Win7\_8\_WOW64\WDT\_DIO\_Setup\_v2.3.0.6(wow64).exe

# Appendix A Using WDT & DIO

The watchdog timer (WDT) function to ensure reliable system operation. The WDT is a hardware mechanism to reset the system if the watchdog timer is expired. Users can start the WDT and keeping resetting the timer to make sure the system or program is running. Otherwise, the system shall be reset.

In this section, we'll illustrate how to use the function library provided by Neosys to program the WDT functions. Currently, WDT driver library supports Windows 10 x64 and WOW64 platform. For other OS support, please contact Neosys Technology for further information.

## Installing WDT\_DIO Library

The WDT\_DIO function library is delivered in the form of a setup package named **WDT\_DIO\_Setup.exe**. In prior to program WDT, you should execute the setup program and install the WDT library. Please use the following WDT\_DIO\_Setup packages according to your operating systems and application.

- For Windows 10 64-bit OS with 64-bit application (x64 mode), please install WDT\_DIO\_Setup\_v2.3.0.6 (x64).exe or later version.
- For Windows 10 64-bit OS with 32-bit application (WOW64 mode), please install WDT\_DIO\_Setup\_v2.3.0.6 (wow64).exe or later version.

## WDT and DIO Library Installation

To setup WDT & DIO Library, please follow instructions below.

1. Execute **WDT\_DIO\_Setup.2.2.8.x.exe**. and the following dialog appears.

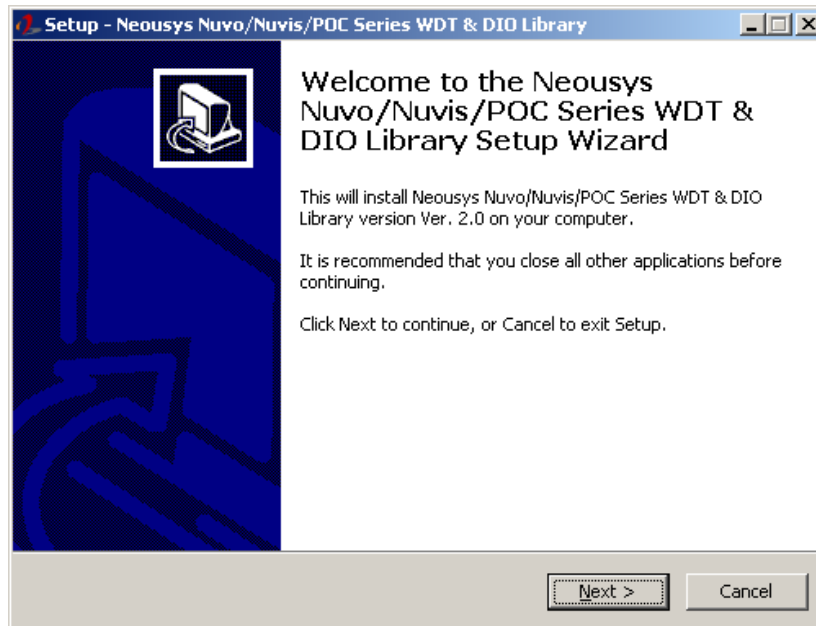

2. Click "Next >" and specify the directory of installing related files. The default directory is *C:\Neosys\WDT\_DIO*.

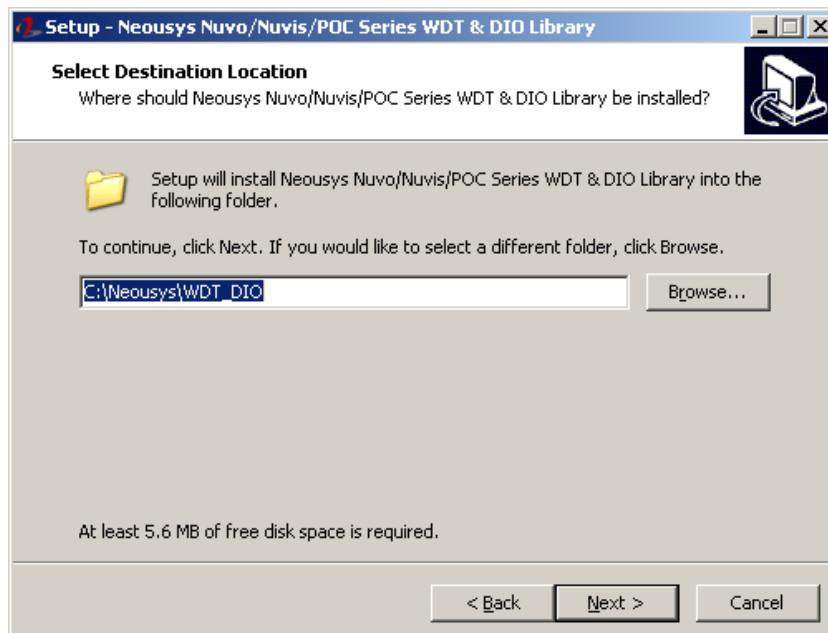

3. Once the installation has finished, a dialog will appear to prompt you to reboot the system. The WDT & DIO library will take effect after the system has rebooted.

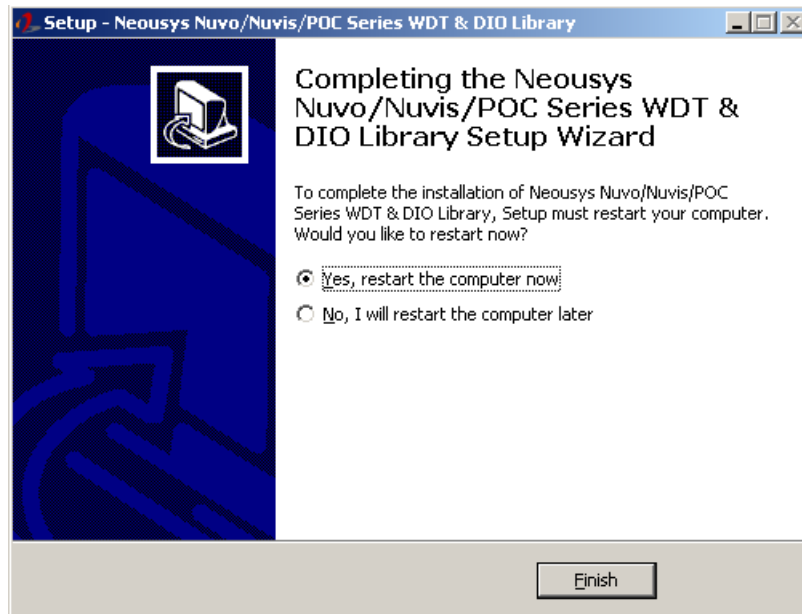

4. When programming your WDT or DIO program, the related files are located in

<b>Header File:</b>	\Include
<b>Library File:</b>	\Lib
<b>Function</b>	\Manual
<b>Reference:</b>	
<b>Sample Code:</b>	\Sample\WDT_Demo (Demo for Watchdog Timer)



## WDT Functions

### InitWDT

<b>Syntax</b>	BOOL InitWDT(void);
<b>Description:</b>	Initialize the WDT function. You should always invoke InitWDT() before set or start watchdog timer.
<b>Parameter</b>	None
<b>Return Value</b>	<b>TRUE:</b> Successfully initialized <b>FALSE:</b> Failed to initialize
<b>Usage</b>	BOOL    bRet = InitWDT()

### SetWDT

<b>Syntax</b>	BOOL SetWDT(WORD tick, BYTE unit);
<b>Description</b>	Set timeout value and unit for watchdog timer. When InitWDT() is invoked, a default timeout value of 255 seconds is assigned.
<b>Parameter</b>	<i>tick</i> WORD value (1 ~ 65535) to indicate timeout ticks. <i>unit</i> BYTE value (0 or 1) to indicate unit of timeout ticks. 0 : unit is minute 1 : unit is second
<b>Return Value</b>	If value of unit is correct (0 or 1), this function returns TRUE, otherwise FALSE.
<b>Usage</b>	WORD    tick=255; BYTE    unit=1; //unit is second. BOOL    bRet = SetWDT(tick, unit); //timeout value is 255 seconds

### StartWDT

<b>Syntax</b>	BOOL StartWDT(void);
<b>Description</b>	Starts WDT countdown. Once started, the WDT LED indicator will begin blinking. If ResetWDT() or StopWDT is not invoked before WDT countdowns to 0, the WDT expires and the system resets.
<b>Parameter</b>	None
<b>Return Value</b>	If the timeout value is given in correct format (WDT started), this function returns TRUE, otherwise FALSE
<b>Usage</b>	BOOL bRet = StartWDT()

### ResetWDT

<b>Syntax</b>	BOOL ResetWDT(void);
<b>Description</b>	Reset the timeout value to the value given by SetWDT().If ResetWDT() or StopWDT is not invoked before WDT countdowns to 0, the WDT expires and the system resets.
<b>Parameter</b>	None
<b>Return Value</b>	Always returns TRUE
<b>Usage</b>	BOOL bRet = ResetWDT()

### StopWDT

<b>Syntax</b>	BOOL StopWDT(void);
<b>Description</b>	Stops the countdown of WDT. When WDT has stopped, the WDT LED indicator stops blinking.
<b>Parameter</b>	None
<b>Return Value</b>	Always returns TRUE
<b>Usage</b>	BOOL bRet = StopWDT()