

# **Neosys Technology Inc.**

**POC-400 Series**

**User Manual**

Revision 1.2

# Table of Contents

Table of Contents .....	2
Legal Information .....	5
Contact Information .....	6
Declaration of Conformity .....	6
Copyright Notice .....	7
Safety Precautions .....	8
Service and Maintenance .....	9
ESD Precautions .....	9
About This Manual .....	10
<b>1 Introduction</b>	
1.1 Specification of POC-400 .....	12
1.2 Specification of POC-410 .....	14
1.3 Dimension .....	16
1.3.1 Superior View .....	16
1.3.2 Front Panel View .....	16
1.3.3 COM Port Panel View .....	17
1.3.4 Bottom View .....	17
1.4 POC-400 Series Mounting Options .....	18
1.4.1 DIN-Rail Mount Clip .....	18
<b>2 System Overview</b>	
2.1 Unpacking the System .....	19
2.2 POC-400 Series Front Panel .....	20
2.2.1 USB 3.1 Gen 1 Port .....	21
2.2.2 2.5G Ethernet Port .....	22
2.2.3 System Status LED .....	23
2.2.4 USB 2.0 Port .....	24
2.2.5 DisplayPort .....	25
2.2.6 CMOS Reset Button .....	26
2.2.7 IEEE 802.3at Power over Ethernet Port (POC-400 only) .....	27
2.2.8 3-Pin Terminal Block .....	28
2.3 POC-400 Series COM Port Panel .....	29
2.3.1 Power Button .....	30
2.3.2 Reset Button .....	30
2.3.3 COM Port (COM1) .....	31
2.3.4 COM Ports (COM2/ COM3/ COM4) .....	32
2.3.5 3.5mm Microphone-in/ Speaker-out Jack .....	33
2.3.6 SMA Antennae Opening .....	33
2.4 POC-400 Series Internal I/O .....	34
2.4.1 SO-DIMM Memory Socket .....	34
2.4.2 M.2 2230 E Key Socket .....	35
2.4.3 M.2 2280 M Key .....	37
2.5 MeziO™ Interface .....	39
2.5.1 MeziO™ Interface Pin Definition .....	40
2.5.2 MeziO™ Modules for POC-400 Series .....	41
<b>3 System Installation</b>	
3.1 Disassembling the System Enclosure .....	43
3.2 Installing Internal Components .....	45
3.2.1 SO-DIMM Installation .....	45
3.2.2 M.2 2280 M Key Module Installation .....	47
3.2.3 M.2 2230 E Key Module Installation .....	49
3.2.4 MeziO™ Module Installation .....	52
3.3 Installing the System Enclosure .....	54

<b>3.4</b>	<b>DIN Rail Installation</b> .....	<b>56</b>
<b>3.5</b>	<b>Wall Mount Installation (Optional Accessory)</b> .....	<b>58</b>
3.5.1	Standard Wall Mount (Optional Accessory).....	58
3.5.2	Vertical Wall Mount (Optional Accessory) .....	59
<b>3.6</b>	<b>Powering On the System</b> .....	<b>60</b>
3.6.1	Powering On Using the Power Button.....	60
3.6.2	Powering On Using An External Non-Latched Switch.....	61
3.6.3	Powering On Using Wake-on-LAN.....	62
<b>3.7</b>	<b>Ignition Power Control (For MeziO-V20 Only)</b> .....	<b>65</b>
3.7.1	Principles of Ignition Power Control .....	65
3.7.2	Additional Features of Ignition Power Control .....	66
3.7.3	Wiring Ignition Signal .....	67
3.7.4	Configure your Windows system.....	68
3.7.5	Operation Modes of Ignition Power Control .....	69

## 4 BIOS Settings

<b>4.1</b>	<b>COM1 Port Configuration</b> .....	<b>72</b>
<b>4.2</b>	<b>COM2/ 3/ 4 Port Configuration</b> .....	<b>73</b>
<b>4.3</b>	<b>C-States</b> .....	<b>74</b>
<b>4.4</b>	<b>Power over Ethernet (POE-400 Only)</b> .....	<b>75</b>
<b>4.5</b>	<b>Wake-on-LAN</b> .....	<b>75</b>
<b>4.6</b>	<b>Power On after Power Failure</b> .....	<b>76</b>
<b>4.7</b>	<b>Position New Boot Device</b> .....	<b>77</b>
<b>4.8</b>	<b>Watchdog Timer</b> .....	<b>78</b>

## 5 OS Support and Driver Installation

<b>5.1</b>	<b>Operating System Compatibility</b> .....	<b>79</b>
<b>5.2</b>	<b>Driver Installation</b> .....	<b>80</b>
5.2.1	Install Drivers Automatically .....	80
5.2.2	Install Drivers Manually .....	81
<b>5.3</b>	<b>Driver for Watchdog Timer and DIO</b> .....	<b>82</b>

## Appendix A Using WDT & DIO

<b>WDT and DIO Library Installation</b> .....	<b>84</b>
<b>WDT Function Reference</b> .....	<b>86</b>
InitWDT .....	86
SetWDT .....	86
StartWDT .....	87
ResetWDT .....	87
StopWDT .....	87
<b>Using DIO Function (With MeziO-R12 Installed)</b> .....	<b>88</b>
Wiring for DIO .....	88
DIO Pin Definition.....	89
<b>DIO Function Reference</b> .....	<b>90</b>
InitDIO.....	90
DIReadLine .....	90
DIReadPort .....	90
DOWriteLine.....	91
DOWritePort.....	91
DOWriteLineChecked .....	92
DOWritePortChecked.....	92
<b>COS Function Reference</b> .....	<b>93</b>
SetupDICOS .....	93
RegisterCallbackDICOS.....	94
StartDICOS .....	94
StopDICOS .....	95
DI COS Example.....	95

## Appendix B PoE On/ Off Control

<b>PoE On/ Off Control Function Reference .....</b>	<b>98</b>
GetStatusPoEPort.....	98
EnablePoEPort.....	99
DisablePoEPort.....	100

# Legal Information

All Neosys Technology Inc. products shall be subject to the latest Standard Warranty Policy

Neosys Technology Inc. may modify, update or upgrade the software, firmware or any accompanying user documentation without any prior notice. Neosys Technology Inc. will provide access to these new software, firmware or documentation releases from download sections of our website or through our service partners.

Before installing any software, applications or components provided by a third party, customer should ensure that they are compatible and interoperable with Neosys Technology Inc. product by checking in advance with Neosys Technology Inc. Customer is solely responsible for ensuring the compatibility and interoperability of the third party's products. Customer is further solely responsible for ensuring its systems, software, and data are adequately backed up as a precaution against possible failures, alternation, or loss.

For questions in regards to hardware/ software compatibility, customers should contact Neosys Technology Inc. sales representative or technical support.

To the extent permitted by applicable laws, Neosys Technology Inc. shall NOT be responsible for any interoperability or compatibility issues that may arise when (1) products, software, or options not certified and supported; (2) configurations not certified and supported are used; (3) parts intended for one system is installed in another system of different make or model.

# Contact Information

---

**Headquarters**  
**(Taipei, Taiwan)**      **Neosys Technology Inc.**  
15F, No.868-3, Zhongzheng Rd., Zhonghe Dist., New Taipei City, 23586, Taiwan  
Tel: +886-2-2223-6182 Fax: +886-2-2223-6183 [Email](#), [Website](#)

---

**Americas**  
**(Illinois, USA)**      **Neosys Technology America Inc.**  
3384 Commercial Avenue, Northbrook, IL 60062, USA  
Tel: +1-847-656-3298 [Email](#), [Website](#)

---

**China**      **Neosys Technology (China) Ltd.**  
Room 612, Building 32, Guiping Road 680, Shanghai  
Tel: +86-2161155366 [Email](#), [Website](#)

---

# Declaration of Conformity

**FCC**      This equipment has been tested and found to comply with the limits for a Class A digital device, pursuant to part 15 of the FCC Rules. These limits are designed to provide reasonable protection against harmful interference when the equipment is operated in a commercial environment. This equipment generates, uses, and can radiate radio frequency energy and, if not installed and used in accordance with the instruction manual, may cause harmful interference to radio communications. Operation of this equipment in a residential area is likely to cause harmful interference in which case the user will be required to correct the interference at own expense.

---

**CE**      The product(s) described in this manual complies with all applicable European Union (CE) directives if it has a CE marking. For computer systems to remain CE compliant, only CE-compliant parts may be used. Maintaining CE compliance also requires proper cable and cabling techniques.

# Copyright Notice

All rights reserved. This publication may not be reproduced, transmitted, transcribed, stored in a retrieval system, or translated into any language or computer language, in any form or by any means, electronic, mechanical, magnetic, optical, chemical, manual or otherwise, without the prior written consent of Neosys Technology, Inc.

---

## **Disclaimer**

This manual is intended to be used as an informative guide only and is subject to change without prior notice. It does not represent commitment from Neosys Technology Inc. Neosys Technology Inc. shall not be liable for any direct, indirect, special, incidental, or consequential damages arising from the use of the product or documentation, nor for any infringement on third party rights.

---

## **Patents and Trademarks**

Neosys, the Neosys logo, Expansion Cassette, MezIO™ are registered patents and trademarks of Neosys Technology, Inc.

Windows is a registered trademark of Microsoft Corporation.

Intel®, Core™ are registered trademarks of Intel Corporation

NVIDIA®, GeForce® are registered trademarks of NVIDIA Corporation

All other names, brands, products or services are trademarks or registered trademarks of their respective owners.

# Safety Precautions

- Read these instructions carefully before you install, operate, or transport the system.
- Install the system or DIN rail associated with, at a sturdy location
- Install the power socket outlet near the system where it is easily accessible
- Secure each system module(s) using its retaining screws
- Place power cords and other connection cables away from foot traffic. Do not place items over power cords and make sure they do not rest against data cables
- Shutdown, disconnect all cables from the system and ground yourself before touching internal modules
- Ensure that the correct power range is being used before powering the device
- Should a module fail, arrange for a replacement as soon as possible to minimize down-time
- By means of a power cord connected to a socket-outlet with earthing connection
- This product is intended to be supplied by a Listed Power Adapter or DC power source, rated 8-35Vdc, 16A, Tma 70 degree C and 5000m altitude during operation. If further assistance is required, please contact Neosys Technology
- If the system is not going to be used for a long time, disconnect it from mains (power socket) to avoid transient over-voltage



# Service and Maintenance

- ONLY qualified personnel should service the system
- Shutdown the system, disconnect the power cord and all other connections before servicing the system
- When replacing/ installing additional components (expansion card, memory module, etc.), insert them as gently as possible while assuring proper connector engagement

# ESD Precautions

- Handle add-on module, motherboard by their retention screws or the module's frame/ heat sink. Avoid touching the PCB circuit board or add-on module connector pins
- Use a grounded wrist strap and an anti-static work pad to discharge static electricity when installing or maintaining the system
- Avoid dust, debris, carpets, plastic, vinyl and styrofoam in your work area.
- Do not remove any module or component from its anti-static bag before installation

# About This Manual

This manual introduces and demonstrates installation procedures of Neosys POC-400 series systems.

## Revision History

Version	Date	Description
1.0	Jul. 2022	Initial release
1.1	Apr. 2023	Updated OS support information
1.2	Jul. 2023	Updated CMOS reset button description
1.3	Feb. 2024	Updated operating system compatibility

# 1 Introduction

Neosys Technology POC-400 is an ultra-compact fanless embedded computer for industrial applications. It utilizes the latest Intel® Elkhart Lake platform Atom® x6425E 4-core CPU that can deliver 1.8x and 2x the performance improvement for the CPU and GPU respectively, compared to the previous generation.

In addition to the performance boost, POC-400 features an ultra-compact design measuring just 56 x 108 x 153 mm, which can easily fit into restricted spaces. The system comes with a DIN-rail mounting chassis and an abundance of front-access I/O interfaces. Featuring three 2.5GBASE-T Ethernet ports with IEEE 802.3 PoE+ capability, they provide higher data bandwidth for devices such as NBASE-T cameras and is backward-compatible with 1000/100/10 Mbps Ethernet. It also has two 4K DisplayPort, 2x USB3.1 Gen1, 2x USB 2.0 and COM ports for general industrial applications.

Supporting Neosys' proprietary MeziO™ interface for function expansion, you can add functions such as isolated DIO, RS-232/422/485, ignition control and 4G/ 5G by installing a MeziO™ module. Moreover, POC-400 comes with an internal M.2 E key socket for a Google TPU or an Intel® Movidius VPU module to transform it into a lightweight AI inference platform at the edge.



Combining the new 10nm Atom® CPU, 2.5G Ethernet ports, PoE+ and ultra-compact enclosure with function expansion capabilities, Neosys' POC-400 is a compact and yet versatile embedded controller that can fuel various industrial applications.

## 1.1 Specification of POC-400

<b>System Core</b>	
Processor	Intel® Elkhart Lake Atom® x6425E quad-core 2.0GHz/3.0GHz 12W processor
Graphics	Integrated Intel® UHD Graphics
Memory	Up to 32 GB DDR4-3200 SDRAM by one SODIMM socket
<b>Panel I/O Interface</b>	
Ethernet	3x 2.5GBASE-T Ethernet ports by Intel® I225 GbE controllers
PoE+	IEEE 802.3at PoE+ on port #2 and #3
USB 3.1	2x USB 3.1 Gen1 (5 Gbps) ports
USB 2.0	2x USB 2.0 ports
Video Port	2x DisplayPort connector, supporting 4096 x 2160 resolution @ 60Hz
Serial Port	1x software-programmable RS-232/422/485 ports (COM1) 3x 3-wire RS-232 ports (COM2/3/4) or 1x RS-422/485 port (COM2)
Audio	1x 3.5 mm jack for mic-in and speaker-out
<b>Storage Interface</b>	
M.2 M key	1x M.2 2280 SATA interface
<b>Internal Expansion Bus</b>	
M.2 E key	1x M.2 2230 E key socket for WiFi, Google TPU or Movidius VPU module
<b>Expandable I/O</b>	1x MeziO™ expansion port for Neousys MeziO™ modules
<b>Power Supply</b>	
DC Input	1x 3-pin pluggable terminal block for 8-35V DC input
<b>Mechanical</b>	
Dimension	56 mm (W) x 108 mm (D) x 153 mm (H)
Weight	0.96kg
Mounting	DIN-rail mount (standard) or Wall-mount (optional)
<b>Environmental</b>	
Operating Temperature	-25°C ~ 70°C */**
Storage Temperature	-40°C ~85°C */**
Humidity	10%~90% , non-condensing

Vibration	Operating, MIL-STD-810G, Method 514.7, Category 4
Shock	Operating, MIL-STD-810G, Method 516.7, Procedure I
EMC	CE/FCC Class A, according to EN 55032 & EN 55035

*\* The 100% CPU/GPU loading for high temperature test is applied using Passmark® BurnInTest™ v8.0. For detail testing criteria, please contact Neosys Technology*

*\*\* For sub-zero operating temperature, a wide temperature HDD drive or Solid State Disk (SSD) is required.*

## 1.2 Specification of POC-410

<b>System Core</b>	
Processor	Intel® Elkhart Lake Atom® x6425E quad-core 2.0GHz/3.0GHz 12W processor
Graphics	Integrated Intel® UHD Graphics
Memory	Up to 32 GB DDR4-3200 SDRAM by one SODIMM socket
<b>Panel I/O Interface</b>	
Ethernet	3x 2.5GBASE-T Ethernet ports by Intel® I225 GbE controllers
USB 3.1	2x USB 3.1 Gen1 (5 Gbps) ports
USB 2.0	2x USB 2.0 ports
Video Port	2x DisplayPort connector, supporting 4096 x 2160 resolution @ 60Hz
Serial Port	1x software-programmable RS-232/422/485 ports (COM1) 3x 3-wire RS-232 ports (COM2/3/4) or 1x RS-422/485 port (COM2)
Audio	1x 3.5 mm jack for mic-in and speaker-out
<b>Storage Interface</b>	
M.2 M key	1x M.2 2280 SATA interface
<b>Internal Expansion Bus</b>	
M.2 E key	1x M.2 2230 E key socket for WiFi, Google TPU or Movidius VPU module
<b>Expandable I/O</b>	1x MeziO™ expansion port for Neousys MeziO™ modules
<b>Power Supply</b>	
DC Input	1x 3-pin pluggable terminal block for 8-35V DC input
<b>Mechanical</b>	
Dimension	56 mm (W) x 108 mm (D) x 153 mm (H)
Weight	0.96kg
Mounting	DIN-rail mount (standard) or Wall-mount (optional)
<b>Environmental</b>	
Operating Temperature	-25°C ~ 70°C */**
Storage Temperature	-40°C ~85°C */**
Humidity	10%~90% , non-condensing
Vibration	Operating, MIL-STD-810G, Method 514.7, Category 4
Shock	Operating, MIL-STD-810G, Method 516.7, Procedure I

EMC	CE/FCC Class A, according to EN 55032 & EN 55035
-----	--

*\* The 100% CPU/GPU loading for high temperature test is applied using Passmark® BurnInTest™ v8.0. For detail testing criteria, please contact Neosys Technology*

*\*\* For sub-zero operating temperature, a wide temperature HDD drive or Solid State Disk (SSD) is required.*

### 1.3 Dimension

#### 1.3.1 Superior View

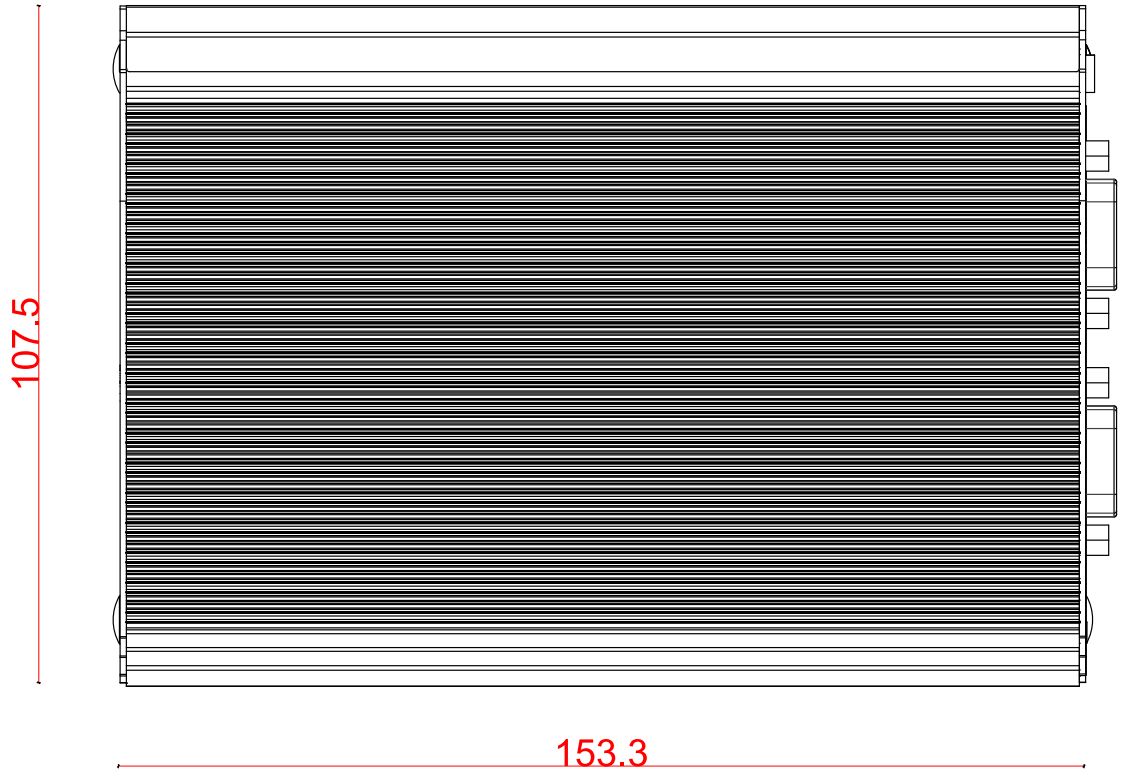

#### 1.3.2 Front Panel View

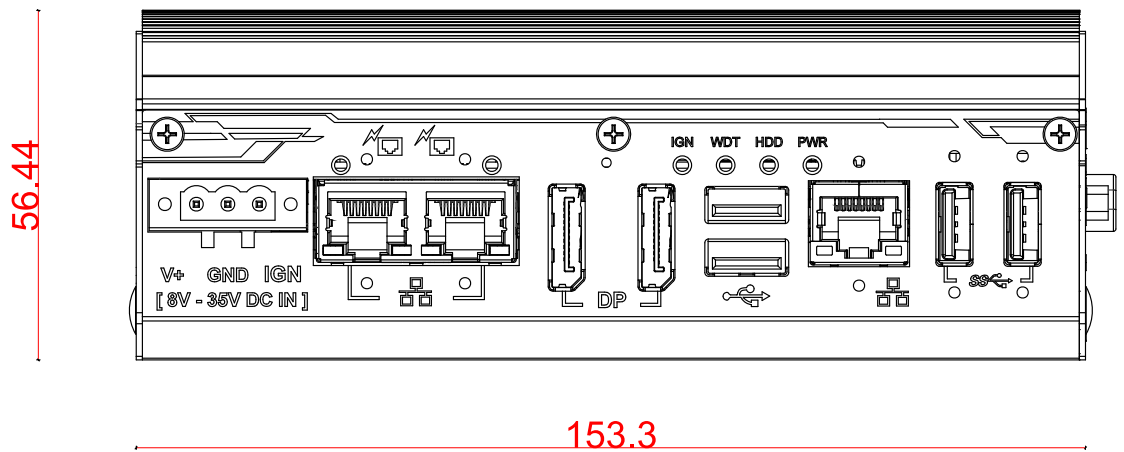



### 1.3.3 COM Port Panel View

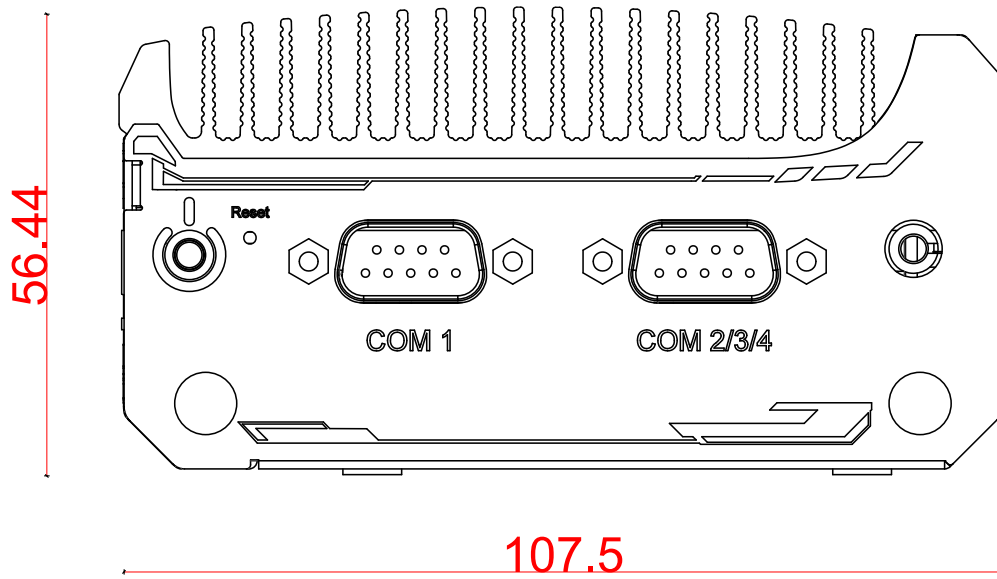

### 1.3.4 Bottom View

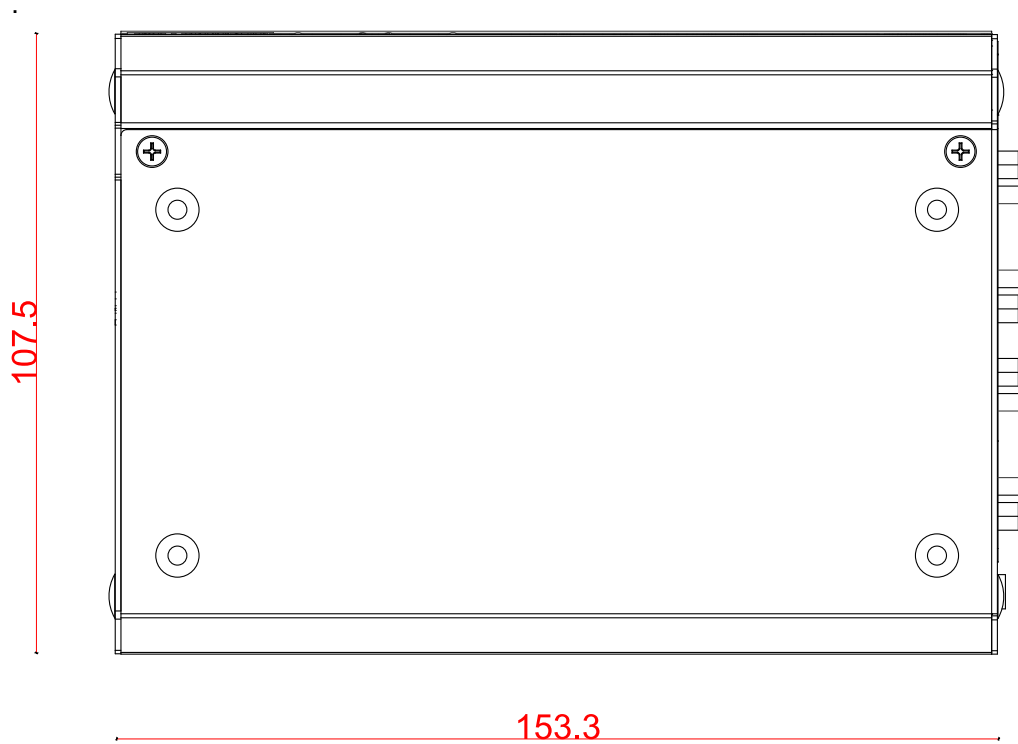

## 1.4 POC-400 Series Mounting Options

The system comes with various mounting options such as DIN-rail and wall-mount bracket. DIN-rail mount clip is shipped with POC-400 series as standard mounting option.

### 1.4.1 DIN-Rail Mount Clip

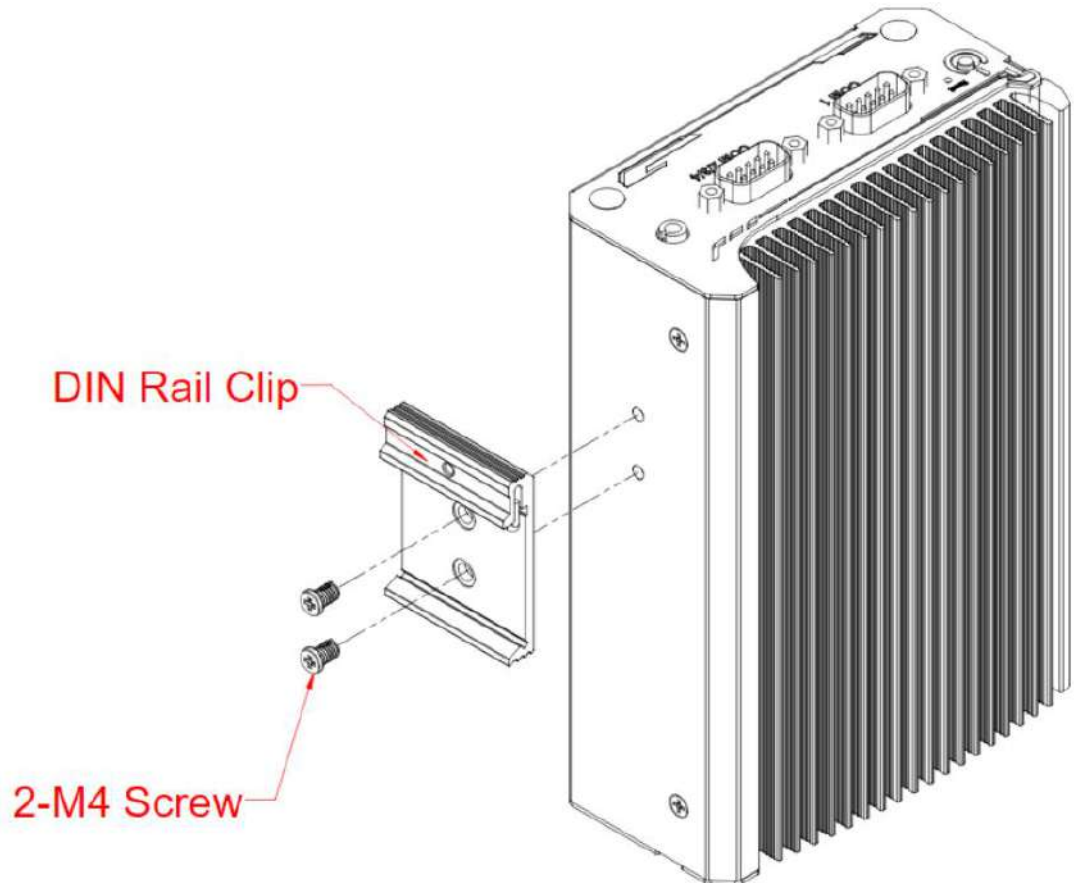

## 2 System Overview

Upon receiving and unpacking your POC-400 series, please check immediately if the package contains all the items listed in the following table. If any item(s) are missing or damaged, please contact your local dealer or Neosys Technology.

### 2.1 Unpacking the System

Item	Description	Qty
1	POC-400 ultra-compact fanless computer (Please verify additionally purchased accessories such as memory module, M.2 SSD, TPU, MezIO, etc.)	1
2	3-pin pluggable terminal block	1
3	Neosys Drivers & Utilities DVD	1
4	DIN-Rail Mount Clip	1
5	Screw package	1

## 2.2 POC-400 Series Front Panel

The front panel of POC-400 systems feature rich I/O ports, it has three 2.5G Ethernet ports (two are PoE+ ports for POC-400), two USB3.1 Gen1 ports, two USB2.0 ports, two DisplayPort ports for video output, CMOS reset button and 3-pin terminal block for DC input.

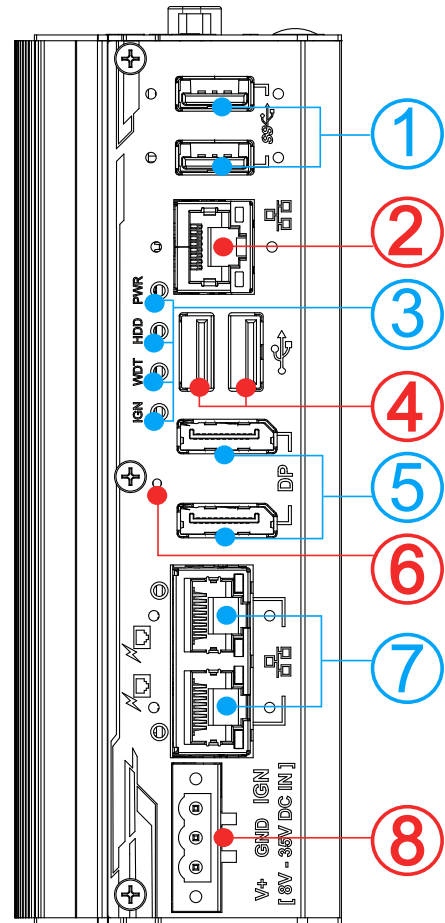

No.	Item	Description
1	<a href="#">USB 3.1 Gen 1 port</a>	The USB 3.1 Gen1 ports support up to 5Gbit/s data transfer bandwidth and are backward compatible with USB 2.0/ 1.1/ 1.0.
2	<a href="#">2.5G Ethernet port</a>	The Ethernet port offers up to 2.5Gb/s transfer bandwidth
3	<a href="#">System status LED</a>	Four system LEDs, Power (PWR), Hard Disk Drive (HDD), Watchdog Timer (WDT) and Ignition control (IGN)
4	<a href="#">USB 2.0 port</a>	The USB 2.0 ports offer up to 480Mbit/s bandwidth and are backward compatible with USB 1.1/ 1.0.
5	<a href="#">DisplayPort</a>	The dual DisplayPort ports can support up to 4096 x 2160 @ 60Hz resolution each.
6	<a href="#">CMOS reset button</a>	Use this button to manually reset the CMOS
7	<a href="#">2.5G PoE+ (POC-400) port/ 2.5G Ethernet (POC-410)</a>	<b>POC-400:</b> 2.5Gb/s Power over Ethernet (PoE) port can provide both data and electric power to devices. <b>POC-410:</b> The Ethernet ports offer up to 2.5Gb/s transfer bandwidth per port.
8	<a href="#">3-pin terminal block (DC/ ignition input)</a>	Compatible with DC power input from 8 to 35V, the terminal block can also be used for ignition signal input.

## 2.2.1 USB 3.1 Gen 1 Port

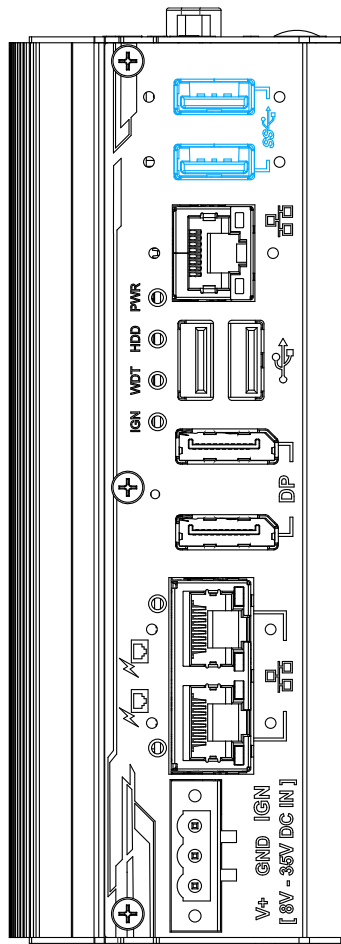

The system offers two USB 3.1 Gen1 (SuperSpeed USB) ports on its front panel. They are implemented by native xHCI (eXtensible Host Controller Interface) controller and are backward compatible with USB 2.0, USB 1.1 and USB 1.0 devices. UEFI USB support is also provided so you can use USB keyboard/mouse in UEFI shell environment

xHCI driver is supported natively in Windows 10, therefore you do not need to install xHCI driver in prior to utilize USB function on POC-400 series.

## 2.2.2 2.5G Ethernet Port

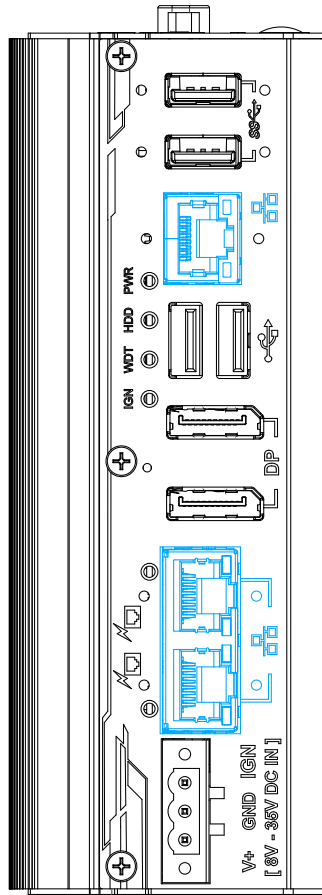

The system offers three 2.5Gb Ethernet ports using Intel® I225 GbE controller. From top to bottom, they are port #1, #2 and #3. When plugged in and connected via the Ethernet cable, the LEDs on the RJ45 connector indicate connection status and speed.

### Active/Link LED (Right)

LED Color	Status	Description
Yellow	Off	Ethernet port is disconnected
	On	Ethernet port is connected and no data transmission
	Flashing	Ethernet port is connected and data is transmitting/receiving

### Speed LED (Left)

LED Color	Status	Description
Off, Green or Orange	Off	10 Mbps
	Green	100 Mbps
	Orange	1000 Mbps
	Orange	2500 Mbps

### 2.2.3 System Status LED

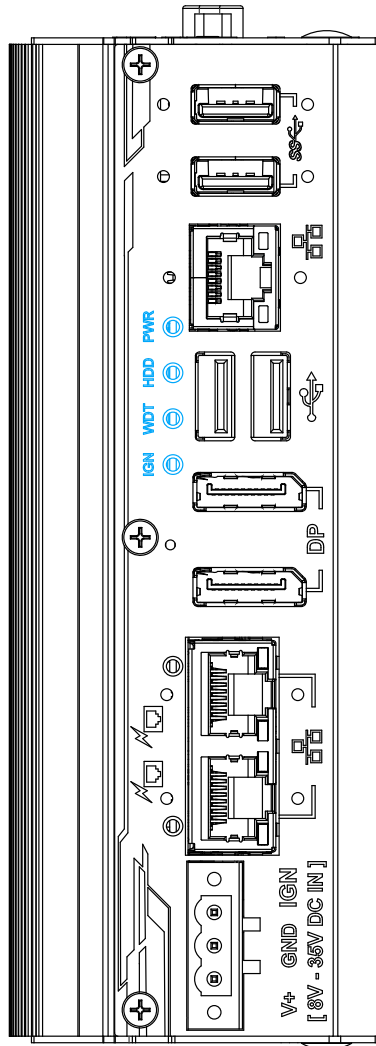

There are four LED indicators on the front panel: PWR, HDD, WDT and IGN. The descriptions of these four LEDs are listed in the following table.

Indicator	Color	Description
PWR	Green	Power indicator, lid when system is on
HDD	Red	Hard drive indicator, flashing when SATA HDD is active
WDT	Yellow	Watchdog timer indicator, flashing when watchdog timer has started
IGN	Yellow	If ignition option (MezIO-V20) is applied, this LED is used to indicate ignition signal status (lid when IGN signal is applied).





## 2.2.5 DisplayPort

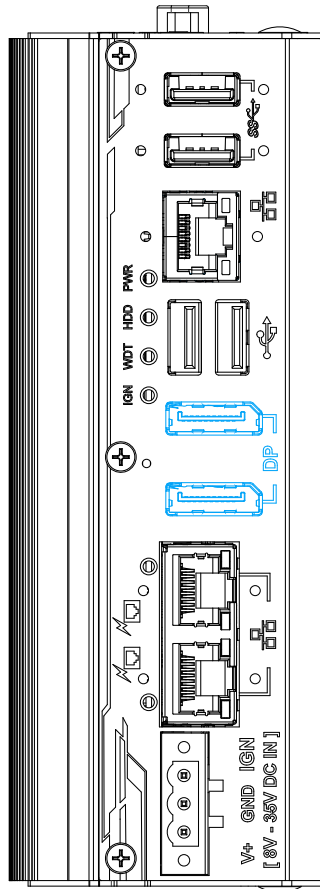

The system has two DisplayPort (DP) outputs which are digital display interfaces that mainly connect video source and carry audio to a display device. When connecting a DP, it can deliver up to 4K UHD (4096 x 2160 @ 60Hz) in resolution. The system is designed to support passive DP adapter/ cable. You can connect to other display devices using DP-to-HDMI cable or DP-to-DVI cable.



**DP-to-HDMI**



**DP-to-DVI**

The system supports dual independent display outputs by connecting display devices DisplayPort connections. To support dual display outputs and achieve best DisplayPort output resolution in Windows, you need to install corresponding graphics drivers. Please refer to section [OS Support and Driver Installation](#) for details.

## 2.2.6 CMOS Reset Button

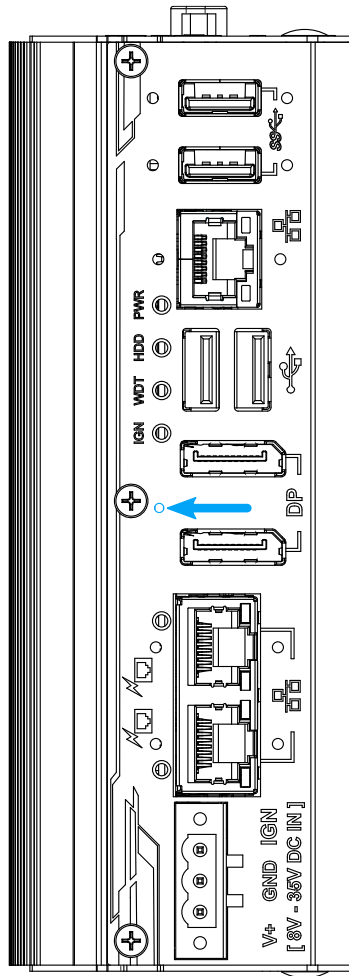

Indicated by the **blue arrow**, the CMOS Reset button is used to manually reset the motherboard BIOS in case of system halt or malfunction. To avoid unexpected operation, it is purposely placed behind the panel. To reset, please use the tip of a pen, press and hold for at least 5 seconds to reset the BIOS.

### 2.2.7 IEEE 802.3at Power over Ethernet Port (POC-400 only)

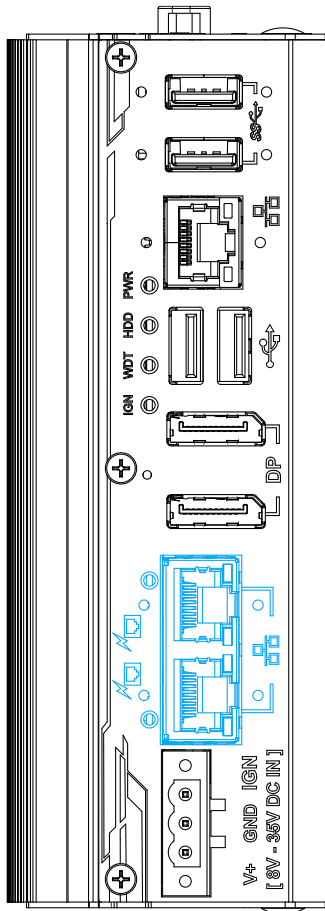

The Gigabit Power over Ethernet (PoE) port supply both power and data on a standard CAT-5/ CAT-6 Ethernet cable. Acting as a PSE (Power Sourcing Equipment), compliant with IEEE 802.3at, each port delivers up to 25W to a Powered Device (PD). PoE automatically detects and determine if the connected device is PoE PD or not before supplying power, making it compatible with standard Ethernet devices as well.

#### Active/Link LED (Right)

LED Color	Status	Description
Yellow	Off	Ethernet port is disconnected
	On	Ethernet port is connected and no data transmission
	Flashing	Ethernet port is connected and data is transmitting/receiving

#### Speed LED (Left)

LED Color	Status	Description
Off, Green or Orange	Off	10 Mbps
	Green	100 Mbps
	Orange	1000 Mbps
	Orange	2500 Mbps

### 2.2.8 3-Pin Terminal Block

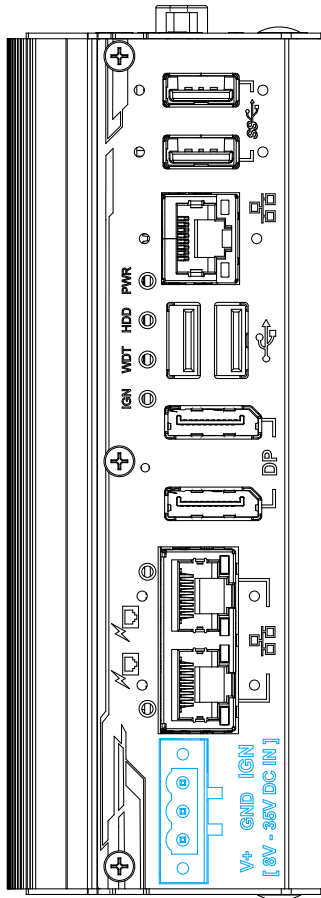

The system accepts a wide range of DC power input from 8 to 35V via a 3-pin pluggable terminal block, which is fit for field usage where DC power is usually provided. The screw clamping mechanism on the terminal block offers connection reliability when wiring DC power.



#### WARNING

*Please make sure the voltage of DC power is correct before you connect it to the system. Supplying a voltage over 35V will damage the system.*

## 2.3 POC-400 Series COM Port Panel

The COM port panel of POC-400 series features additional I/O functions, such as a 3.5mm speaker-out/ microphone-in jack, COM ports and antenna holes for antenna installation.

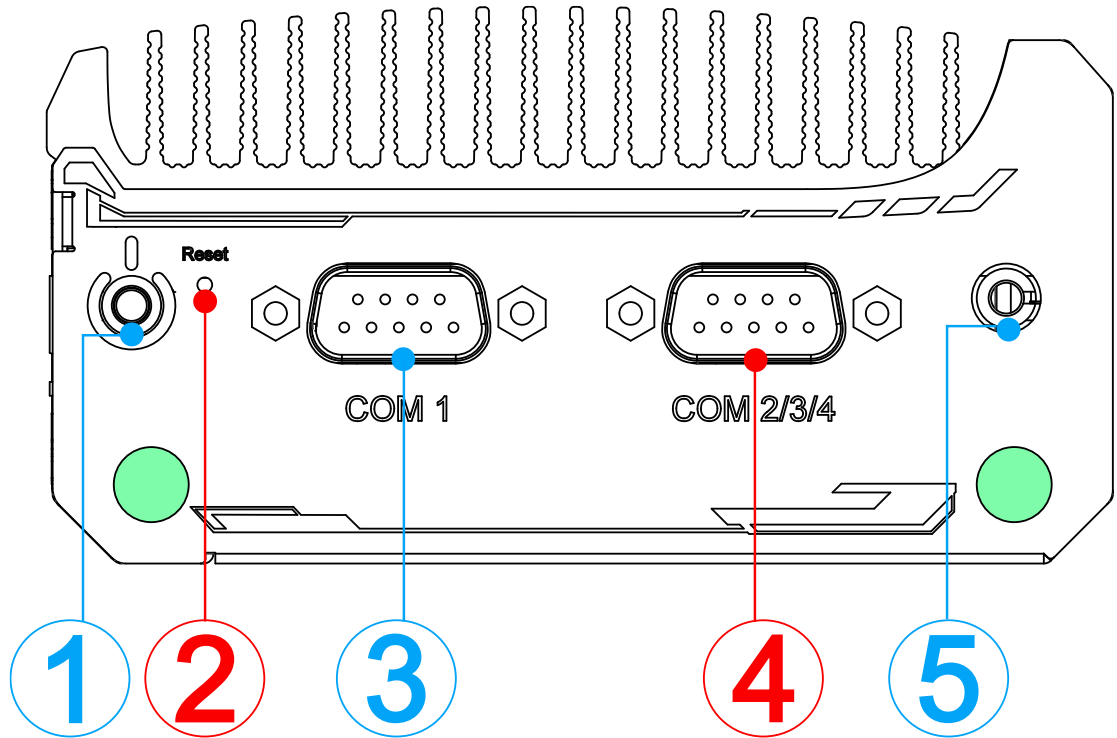

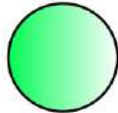
No.	Item	Description
1	<a href="#">Power button</a>	Use this button to turn on or shutdown the system.
2	<a href="#">Reset button</a>	Use this button to manually reset the system.
3	<a href="#">COM port 1</a>	Software programmable RS-232/ 422/ 485 port
4	<a href="#">COM port 2/ 3/ 4</a>	<b>Can be configured as:</b> <b>COM2:</b> single RS-422/ 485 port <b>COM2/ COM3/ COM4:</b> three 3-wire RS-232 ports
5	<a href="#">3.5mm microphone-in/ speaker-out jack</a>	3.5mm jack for speaker-out or microphone-input.
		Opening reserved for SMA antenna installation

### 2.3.1 Power Button

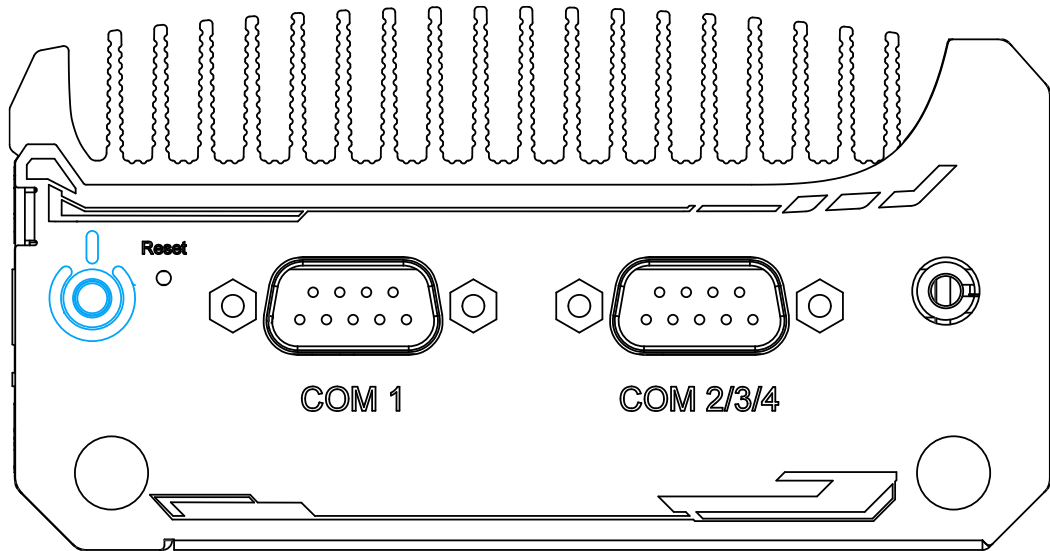

The power button is a non-latched switch for ATX mode on/off operation. Press to turn on the system, PWR LED should light up and to turn off, you can either issue a shutdown command in the OS, or just press the power button. In case of system halts, you can press and hold the power button for 5 seconds to force-shutdown the system. Please note that there is a 5 seconds interval between two on/off operations (i.e. once turning off the system, you will need to wait for 5 seconds to initiate another power-on operation).

### 2.3.2 Reset Button

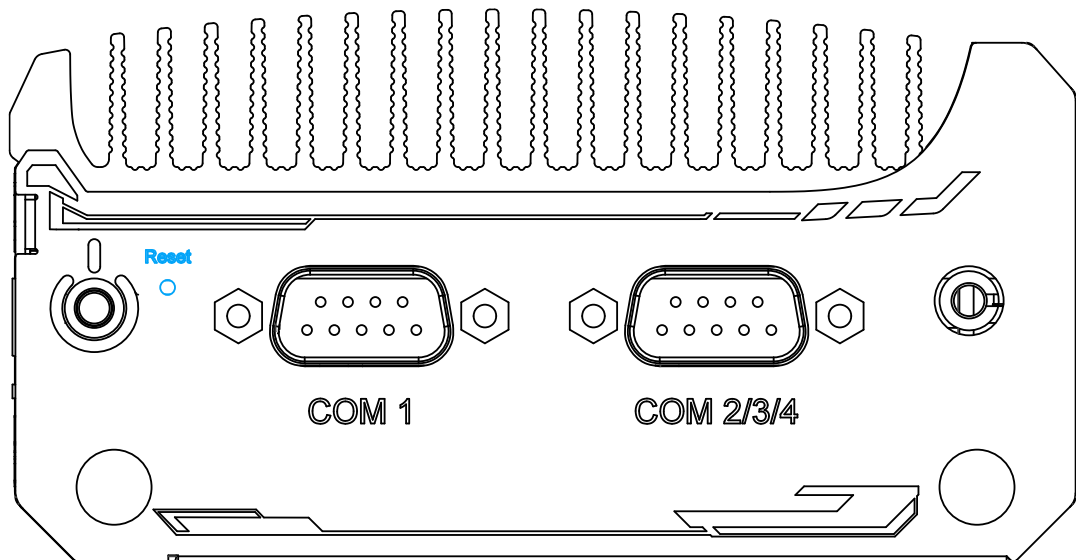

The reset button is used to manually reset the system in case of system halt or malfunction. To avoid unexpected reset, the button is purposely placed behind the panel. To reset, please use a pin-like object (eg. tip of a pen) to access the reset button.

### 2.3.3 COM Port (COM1)

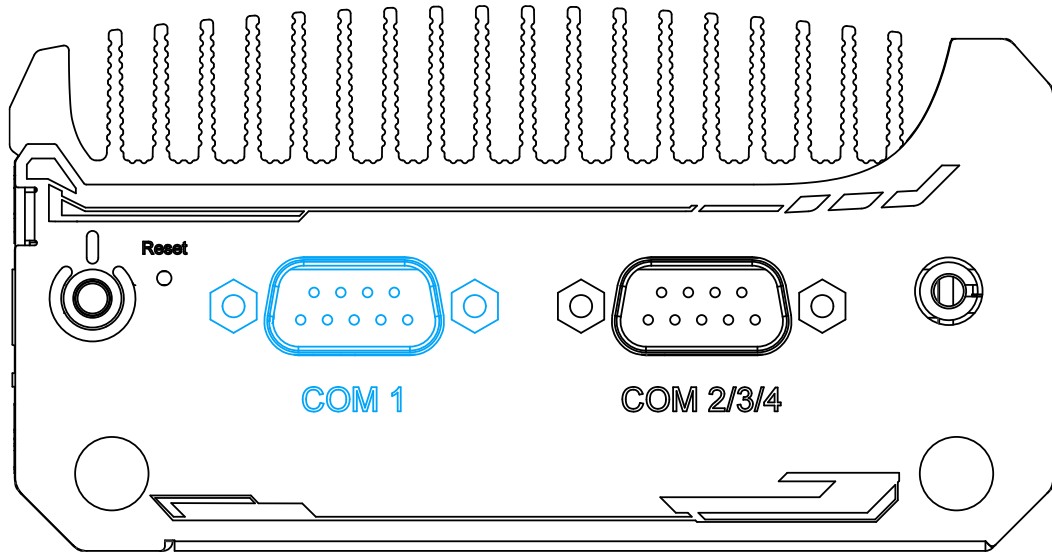

Implemented using industrial-grade ITE8786 Super IO chip (-40 to 85°C) and provide up to 921600 bps baud rate, COM1 is a software-configurable RS-232/422/485 port via 9-pin D-Sub male connector. The operation mode, slew rate and termination of COM1 can be set in BIOS setup utility. The following table describes the pin definition of COM ports.

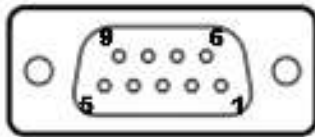

Pin#	COM1		
	RS-232 Mode	RS-422 Mode	RS-485 Mode (Two-wire 485)
1	DCD		
2	RX	422 TXD+	485 TXD+/RXD+
3	TX	422 RXD+	
4	DTR	422 RXD-	
5	GND	GND	GND
6	DSR		
7	RTS		
8	CTS	422 TXD-	485 TXD-/RXD-
9	RI		

### 2.3.4 COM Ports (COM2/ COM3/ COM4)

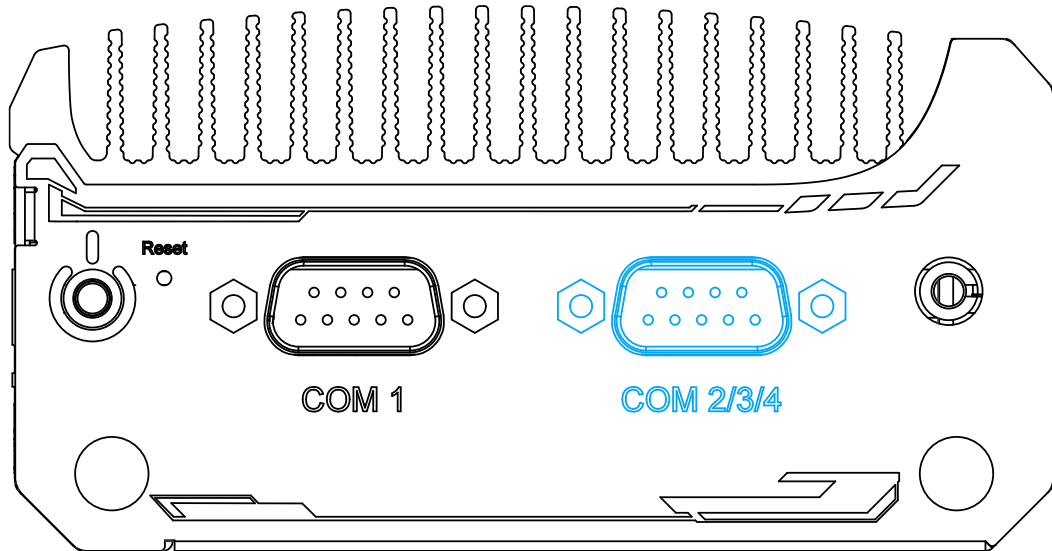

Implemented using industrial-grade ITE8786 Super IO chip (-40 to 85°C) and provide up to 921600 bps baud rate, the second D-Sub male connector (COM2/ 3/ 4) can be configured in BIOS as single RS-422/ 485 port (COM2) or three 3-wire RS-232 ports (COM2/COM3/COM4). Please refer to [COM2/ 3/ 4 Port Configuration](#) for configuring operation mode. An optional 1-to-3 Y-cable is available to connect three RS-232 devices.

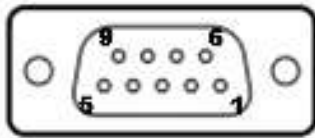

**COM2/ 3/ 4 Pin**



**1-to-3 Y-cable**

The following table describes the pin definition of the COM port

	3-port RS-232 COM2/ 3/ 4		
Pin#	COM2	COM3	COM4
1			
2	RX		
3	TX		
4		TX	
5	GND	GND	GND
6		RX	
7			TX
8			RX
9			

	Single port RS-422/ 485	
Pin#	RS-422	RS-485
1		
2	TxD+	TxD+/ RxD+
3	RxD+	
4	RxD-	
5	GND	GND
6		
7		
8	TxD-	TxD-/ RxD-
9		



### 2.3.5 3.5mm Microphone-in/ Speaker-out Jack

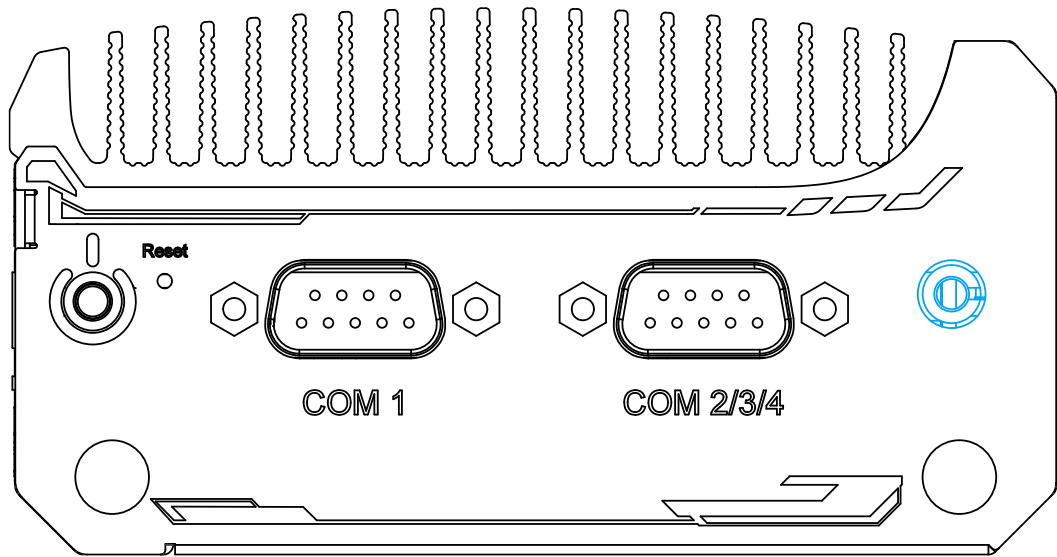

There is a single 3.5mm audio jack on the top panel. The port is used for microphone input as well as speaker output. To utilize the audio function in Windows, you need to install corresponding drivers. Please refer to the section, [Driver Installation](#).

### 2.3.6 SMA Antennae Opening

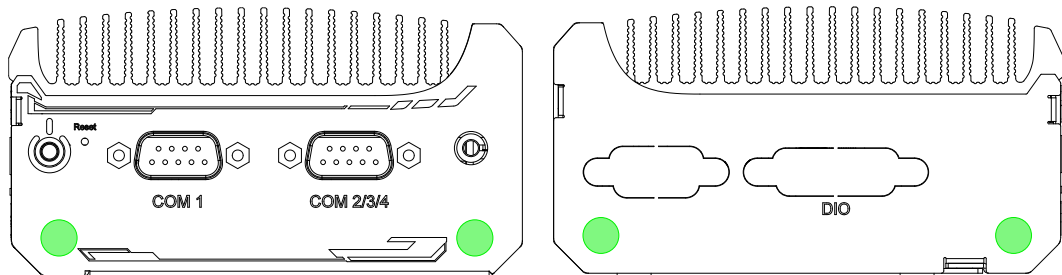

COM port side

DIO reserved port side

The system offers four SMA antenna openings reserved for SMA antenna installations. Users can take advantage of these four openings when installing M.2 E key module for wireless communication reception such as WiFi 5 or WiFi 6.

## 2.4 POC-400 Series Internal I/O

The system's internal I/O connectors consist of a SO-DIMM socket, M.2 2280 M key SATA interface port, M.2 E key port and a MezIO™ port for application-oriented expansion purposes.

### 2.4.1 SO-DIMM Memory Socket

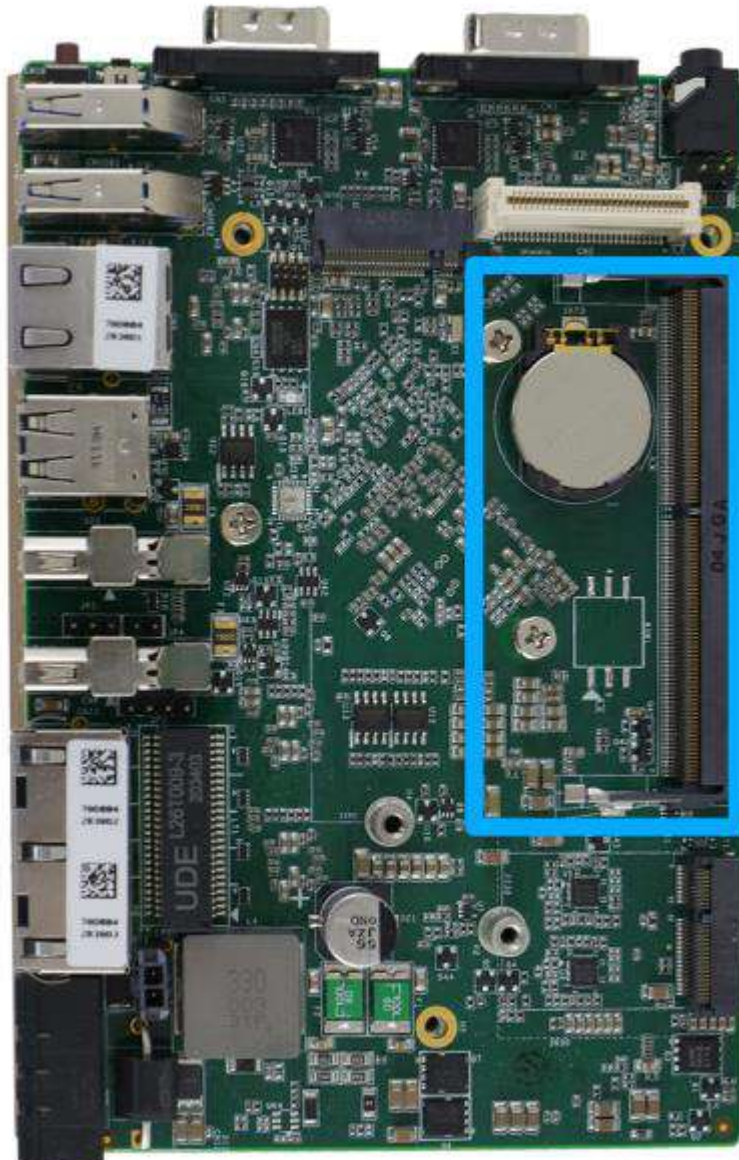

The system has an internal SO-DIMM slot supporting a single DDR4-3200 memory module up to 32GB in capacity.

### 2.4.2 M.2 2230 E Key Socket

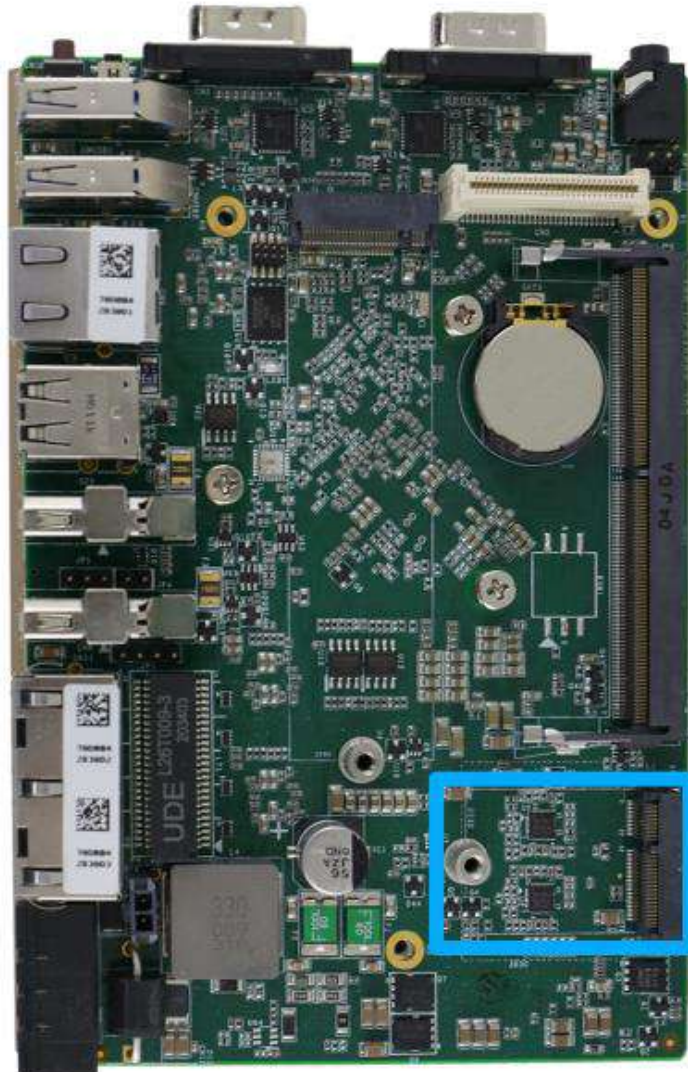

The system has an M.2 2230 E key socket that offers PCIe Gen3 x1 and USB2.0 signal for WiFi module installation.

For SMA antenna installation, there are four dedicated openings located on both sides of the chassis.

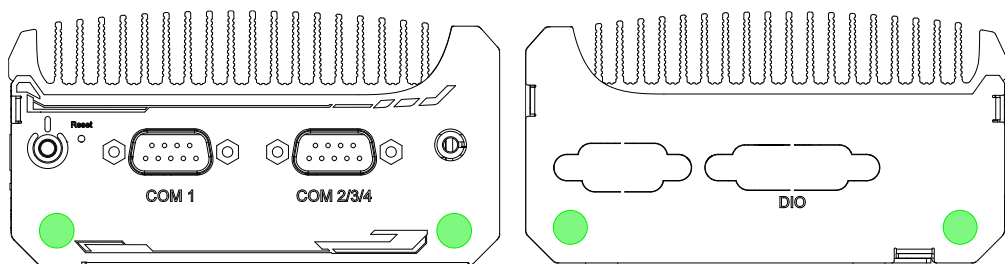

COM port side

DIO reserved port side

**M.2 2230 E Key Pin Definition**

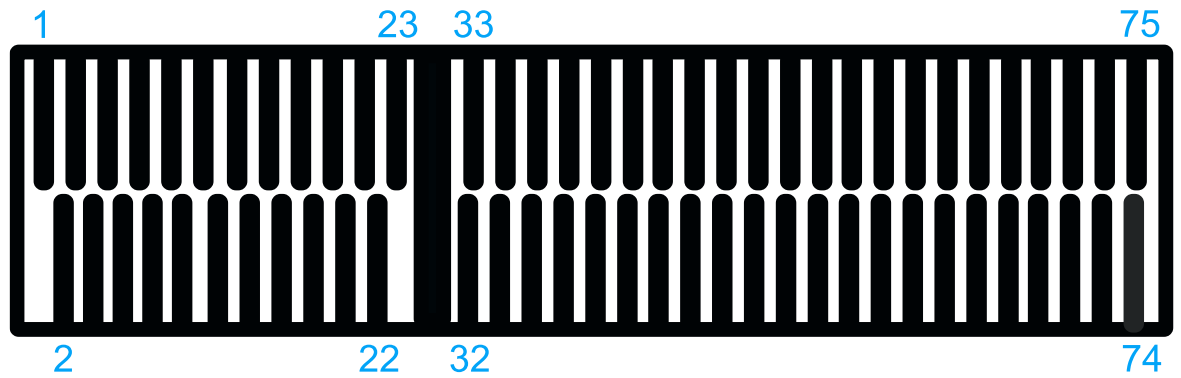

Pin #	Signal	Pin #	Signal
1	GND	2	+3V3
3	USB_D+	4	+3V3
5	USB_D-	6	
7	GND	8	
9		10	-
11		12	
13		14	
15		16	
17		18	GND
19		20	
21	-	22	-
23	-		
Mechanical Key			
33	GND	32	
35	PETP0	34	
37	PETN0	36	
39	GND	38	
41	PER P0	40	
43	PER N0	42	
45	GND	44	
47	REFCLK_P0	46	
49	REFCLK_N0	48	
51	GND	50	
53	CLKREQ#	52	PERST#
55		54	
57	GND	56	W_DISABLE#
59		58	
61		60	
63	GND	62	
65		64	
67		66	
69	GND	68	
71		70	
73		72	+3V3
75	GND	74	+3V3

### 2.4.3 M.2 2280 M Key

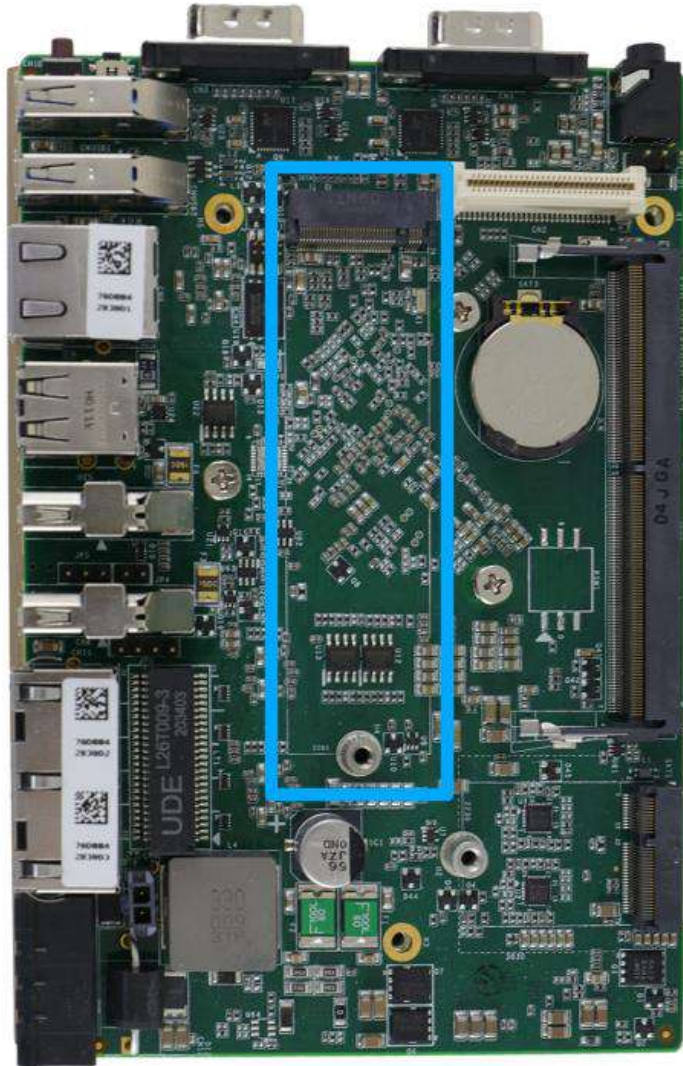

The system has an M.2 2280 slot (SATA signal only) for you to install an M.2 SATA SSD for faster access over traditional hard disk drives.



#### NOTE

*The M.2 slot is only compatible with SATA signal M.2 SSD only.*

**M.2 2280 M Key Pin Definition**

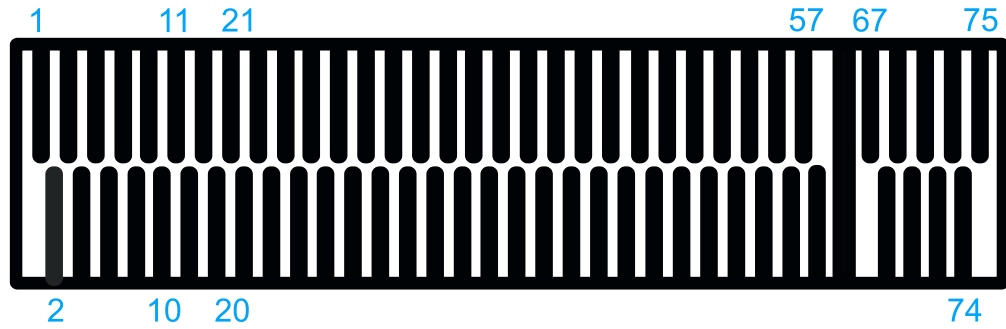

Pin #	Signal	Pin #	Signal
1	GND	2	+3V3
3	GND	4	+3V3
5		6	-
7		8	-
9	GND	10	DAS/DSS N
11		12	+3V3
13		14	+3V3
15	GND	16	+3V3
17		18	+3V3
19		20	-
21	GND	22	-
23		24	-
25		26	-
27	GND	28	-
29		30	-
31		32	-
33	GND	34	-
35		36	DEVSLP
37		38	-
39	GND	40	-
41	SATA-B+	42	-
43	SATA-B-	44	-
45	GND	46	-
47	SATA-A-	48	-
49	SATA-A+	50	PERST N
51	GND	52	-
53		54	-
55		56	-
57	GND	58	-
<b>Mechanical Key</b>			
67	-	68	SUSCLK
69	PEDET	70	+3V3
71	GND	72	+3V3
73	GND	74	+3V3
75	GND		

## 2.5 MezIO™ Interface

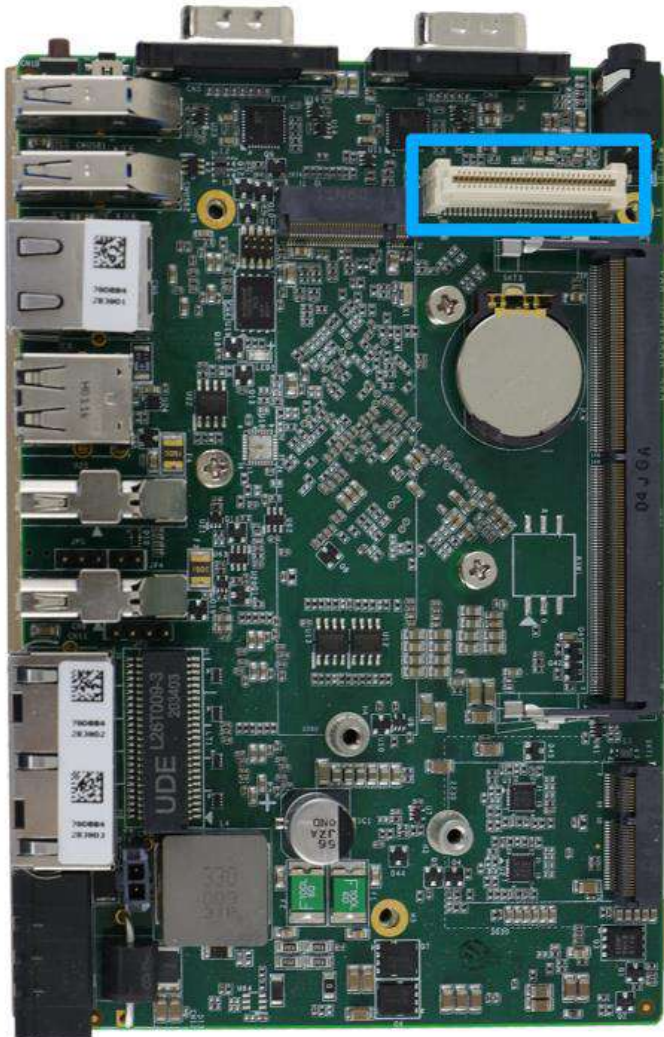

MezIO™ is an innovative interface designed for integrating application-oriented I/O functions into an embedded system. It offers computer signals, power rails and control signals via a high-speed connector. MezIO™ is also mechanically reliable benefited from its 3-point mounted mezzanine structure. A MezIO™ module can leverage these signals to implement comprehensive I/O functions.

POC-400 series incorporates MezIO™ interface and universal mechanical design to accommodate Neusys' standard MezIO™ modules. For customers who want to develop their own MezIO™ module, Neusys provides MezIO™ design documents on a NDA basis. Please contact Neusys for further information.

## 2.5.1 MezIO™ Interface Pin Definition

MezIO™ interface leverages FCI BERGSTAK® board-to-board connector to provide interconnectivity of high-speed signals. The receptacle part on the PCBA is FCI 61082-063402LF while the plug part on the MezIO™ module is FCI 61083-064402LF. Please refer to the following table for signal definition of its 60-pos connector.

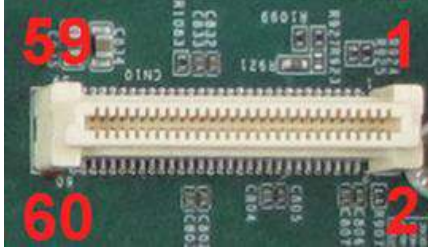









Function Description	Signal	Pin#	Pin#	Signal	Function Description
Reserved	Reserved	1	2	PCIE_TXP_0	PCIe data pair
Reserved	Reserved	3	4	PCIE_TXN_0	PCIe data pair
Reserved	Reserved	5	6	GND	Ground
Reserved	Reserved	7	8	PCIE_RXP_0	PCIe data pair
System S4 signal	SLP_S4#	9	10	PCIE_RXN_0	PCIe data pair
Ground	GND	11	12	CLK100_P_0	PCIe clock pair
Reserved	Reserved	13	14	CLK100_N_0	PCIe clock pair
Ground	GND	15	16	GND	Ground
Reserved	UID_LED	17	18	PCIE_TXP_1	PCIe data pair
Platform reset	PLT_RST#	19	20	PCIE_TXN_1	PCIe data pair
USB data pair	USBP5_N	21	22	PCIE_RXP_1	PCIe data pair
USB data pair	USBP5_P	23	24	PCIE_RXN_1	PCIe data pair
Ground	GND	25	26	GND	Ground
SMB bus	SMB_DATA	27	28	CLK100_P_1	PCIe clock pair
SMB bus	SMB_CLK	29	30	CLK100_N_1	PCIe clock pair
N/C	N/C	31	32	GND	Ground
N/C	N/C	33	34	N/C	N/C
Ground	GND	35	36	N/C	N/C
N/C	N/C	37	38	GND	Ground
N/C	N/C	39	40	N/C	N/C
Power button	PWRBTN#	41	42	N/C	N/C
Reserved	Reserved	43	44	RXD4	SIO COM4
PCH GPIO	GPIO_RISE	45	46	TXD4	SIO COM4
PCH GPIO	GPIO_RISE	47	48	RXD5	SIO COM5
PCH GPIO	GPIO_RISE	49	50	TXD5	SIO COM5
Ground	GND	51	52	GND	Ground
3.3V power	P3V3	53	54	P1V8	1.8V power
3.3V power	P3V3	55	56	GND	Ground
5V power	P5V	57	58	P12V	12V power
5V power	P5V	59	60	P12V	12V power



## 2.5.2 MezIO™ Modules for POC-400 Series

Neousys offers MezIO™ modules to expand I/O functions for Neousys systems. With the addition of a MezIO™ module into your system, it offers extra RS-232/ 422/ 485 ports, isolated digital I/ O, 2.5" HDD/ SSD accommodation, USB or ignition power control.

Model	Description	Product Photo
<b>MezIO-R11</b>	SATA port	
<b>MezIO-R12</b>	SATA port + 4x isolated DI/ 4x isolated DO	
<b>MezIO-C180-50</b>	4-port RS-232/422/485 + 4-port RS-232	
<b>MezIO-C181-50</b>	4-port RS-232/422/485 + 4-port RS-422/485	
<b>MezIO-D220-50*</b>	8-CH isolated DI + 8-CH isolated DO	
<b>MezIO-D230-50*</b>	16-CH isolated DI + 16-CH isolated DO	
<b>MezIO-V20</b>	16-mode ignition power control	
<b>MezIO-U4-30</b>	4x USB3.1 Gen1 ports	

## 3 System Installation

Before disassembling the system enclosure and installing components and modules, please make sure you have done the following:

- It is recommended that only qualified service personnel should install and service this product to avoid injury or damage to the system.
- Please observe all ESD procedures at all times to avoid damaging the equipment.
- Before disassembling your system, please make sure the system has powered off, all cables and antennae (power, video, data, etc.) are disconnected.
- Place the system on a flat and sturdy surface (remove from mounts or out of server cabinets) before proceeding with the installation/ replacement procedure.

### 3.1 Disassembling the System Enclosure

To install necessary components such as memory module, M.2 modules or MezIO™ module, you need to disassemble the POC-400 system enclosure:

1. To disassemble POC-400, unfasten the screws shown in the following illustrations.



Front panel



Rear panel

2. Unfasten the screws at the bottom of the enclosure.



3. Gently slide the enclosure open.



4. Remove the SO-DIMM module heatsink by unscrewing the screws indicated to gain access to internal expansion slots.



## 3.2 Installing Internal Components

### 3.2.1 SO-DIMM Installation

There is one SO-DIMM memory slot on POC-400 series motherboard. Please follow the procedures below to install the memory module.

1. [Disassemble the system enclosure](#)
2. The SO-DIMM slot can be located once the enclosure and heatsink have been removed.

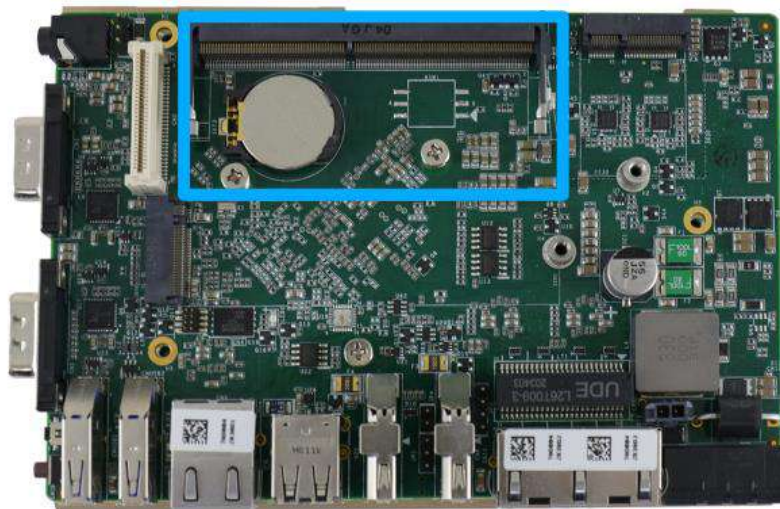

3. **To install**, insert the gold finger end of the SO-DIMM on a 45 degree angle into the slot and gently push the SO-DIMM down until it clips-in.

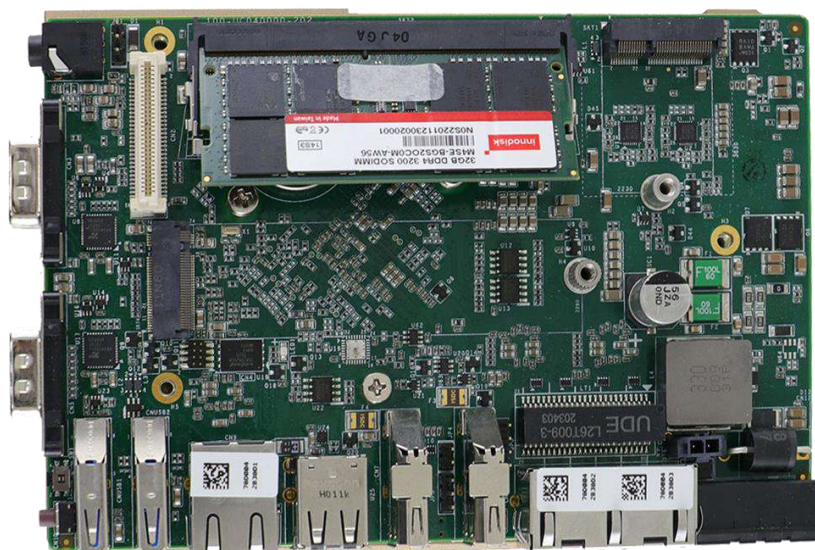

- Remove the memory thermal pad cover and secure the heatsink with the screws indicated.

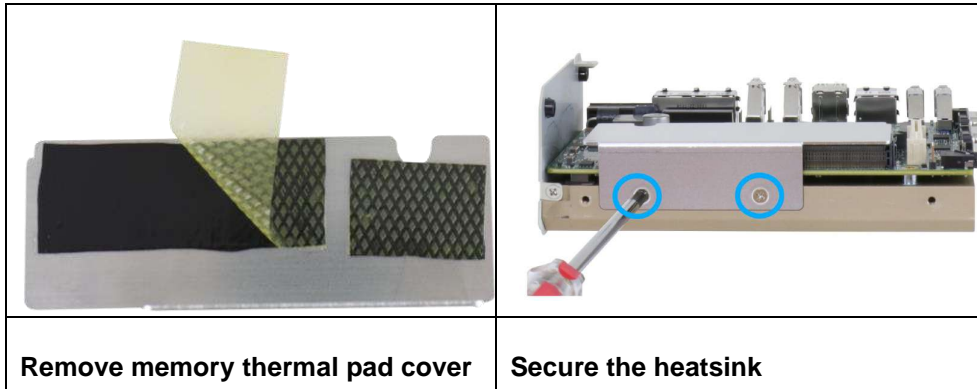

- [Reinstall the system enclosure.](#)

### 3.2.2 M.2 2280 M Key Module Installation

There is an M.2 2280 M key module expansion slot on POC-400 series motherboard. Please follow the procedures below for installation.

1. [Disassemble the system enclosure.](#)
2. The M.2 2280 M key expansion can be located once the enclosure has been removed.

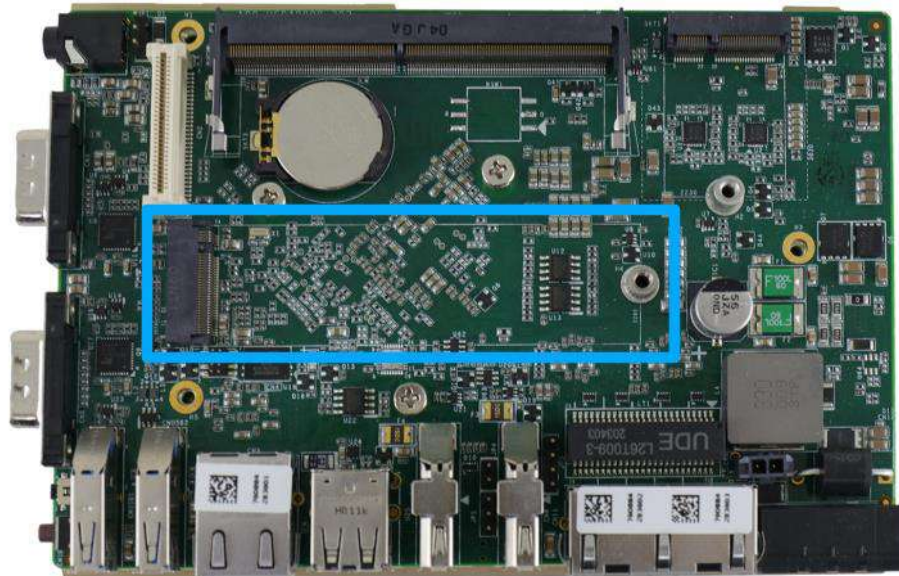

3. Insert the M.2 2280 module on a 45 degree angle.

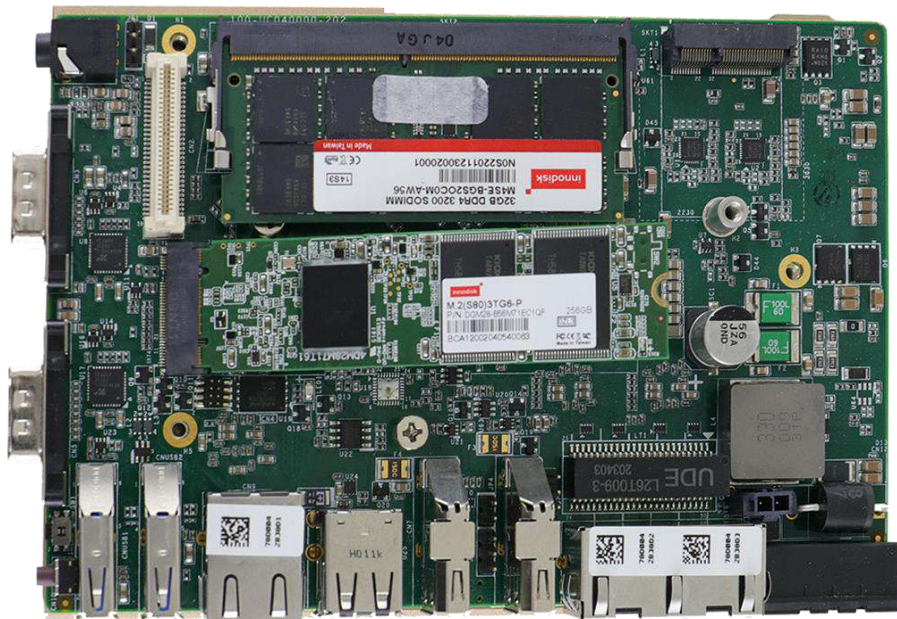

4. Gently press the card down and secure with a screw.

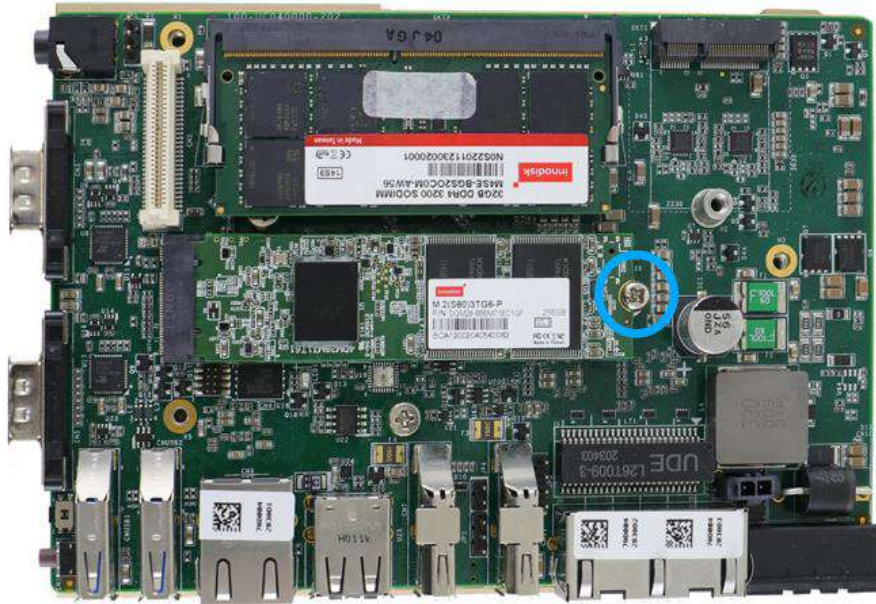

5. [Reinstall the system enclosure.](#)



### 3.2.3 M.2 2230 E Key Module Installation

There is an M.2 E key expansion slot on POC-400 series motherboard for WiFi, Google TPU or Movidius VPU module installation. Please follow the procedures below for installation.

1. [Disassemble the system enclosure.](#)
2. The M.2 E key slot can be located once the enclosure and the heatsink has been removed.

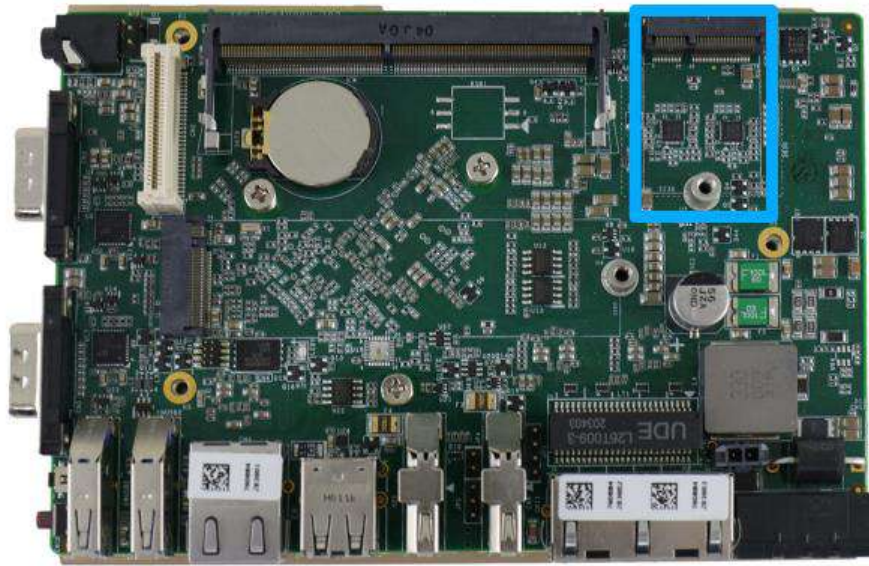

3. **To install**, insert M.2 E key module's gold finger on a 45 degree angle into the socket, gently press the module down and secure it with a screw.

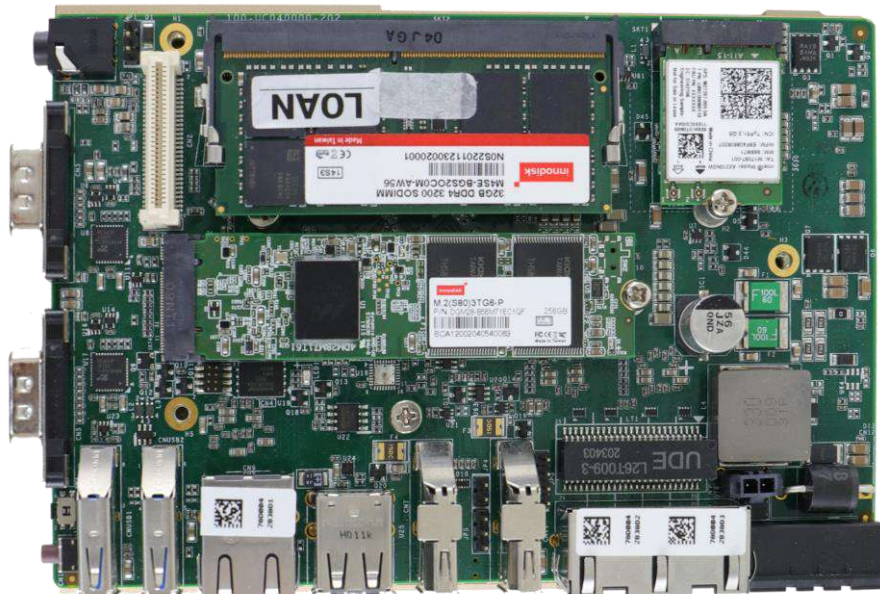

- If you are installing a WiFi module, you will need to install the module's antennae (please refer to the module's user manual on antennae cable connection).

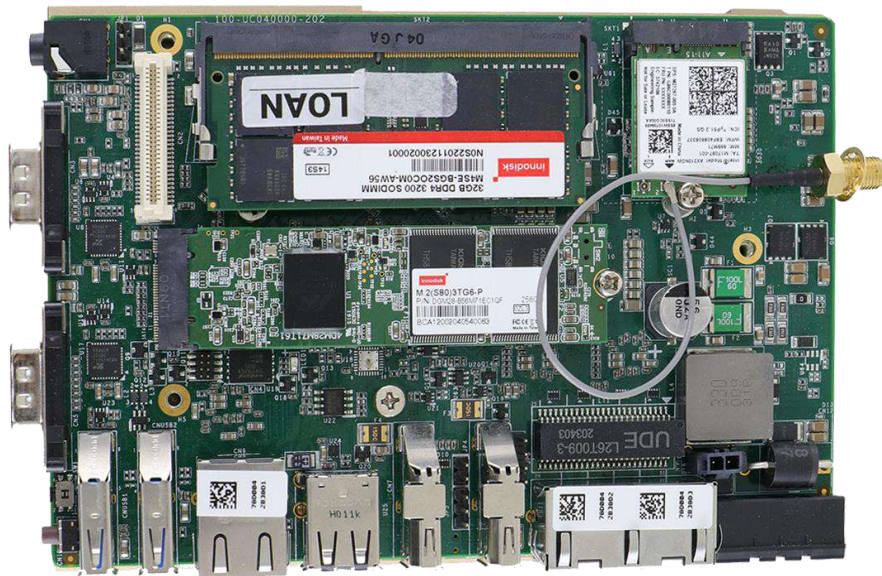

- Remove the M.2 E key thermal pad cover and secure the heatsink with the screws indicated.

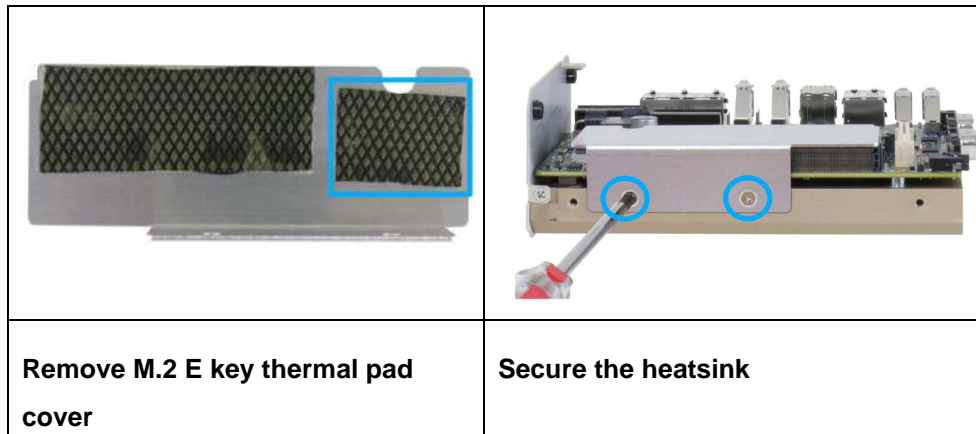

- Remove the Antennae cover from the enclosure.

7. Please refer to the illustration below to secure the SMA antenna.

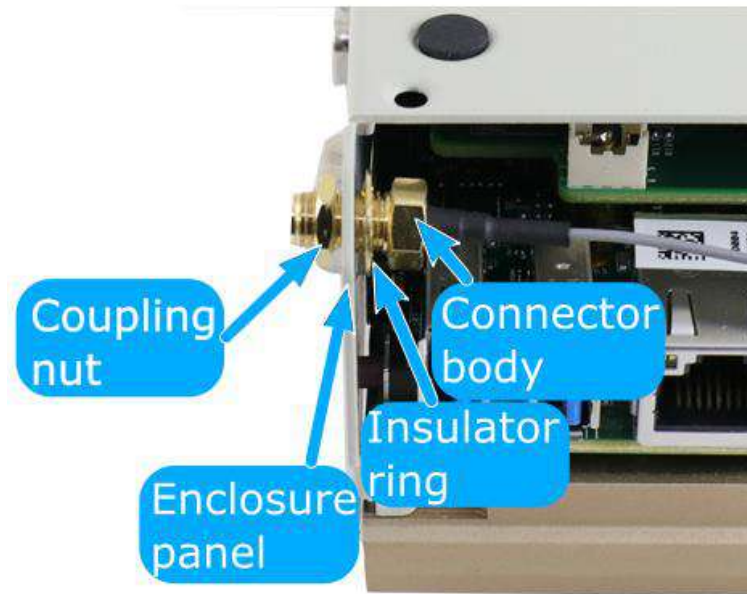

**Secure antenna body on enclosure**



**Install the external antenna**

8. [Reinstall the system enclosure](#) and attach the external antennae to complete the installation.

### 3.2.4 MeziO™ Module Installation

The system comes with a MeziO™ module expansion slot. For specific MeziO™ module I/O functionalities, please refer to the [MeziO™ Module](#) section. For installation, please refer to the following procedure.

1. [Disassemble the system enclosure](#).
2. The MeziO™ module expansion slot can be located once the enclosure has been removed.

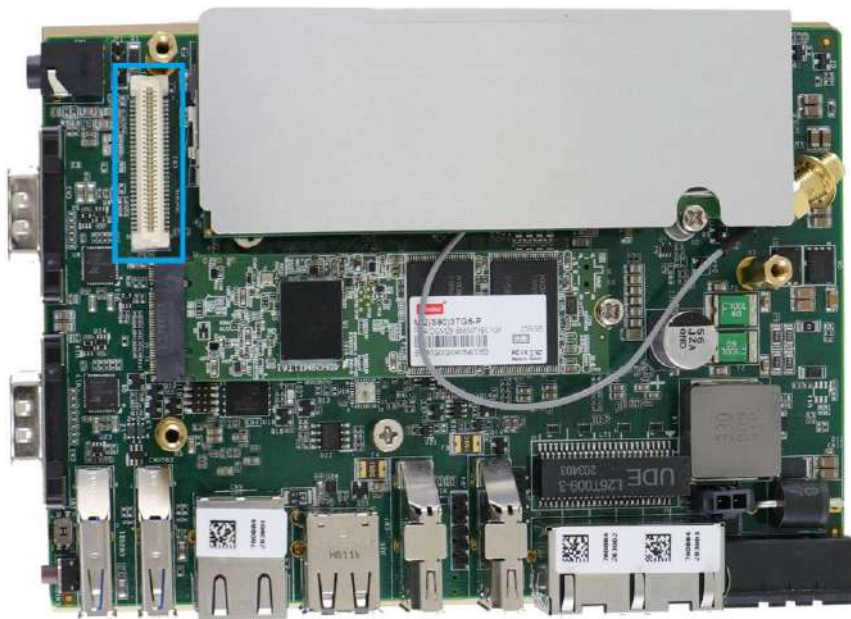

3. The stand-off hex bolts are shipped with MeziO module. POC-400 comes with M3, P-head screws, we need to remove P-head screws and replace them with stand-off bolts

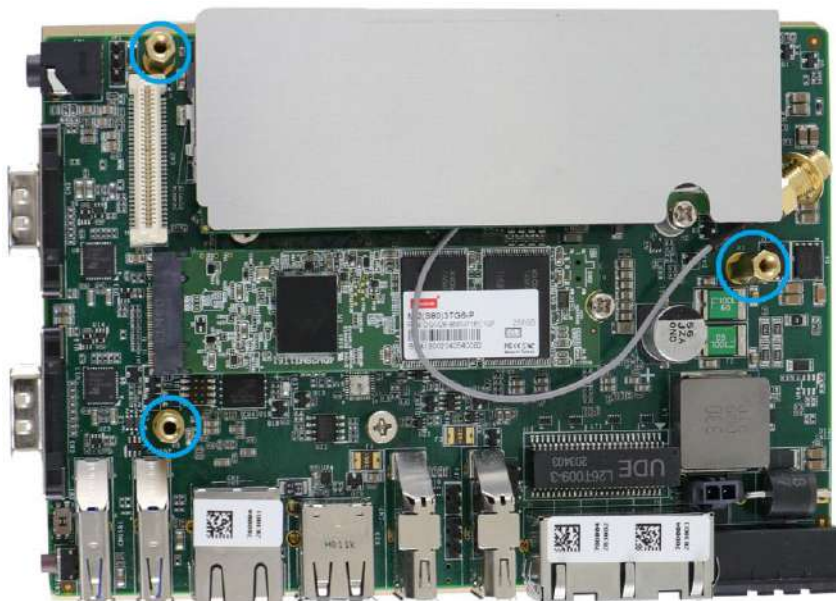

4. To install, match the three (3) screw holes to the standoffs and the MeziO™ port, gently lower the module onto the PCBA. The MeziO™ port should engage if the three (3) standoffs and screw holes meet. Then using the three (3) screws supplied, secure the module by fastening a screw on each standoff.

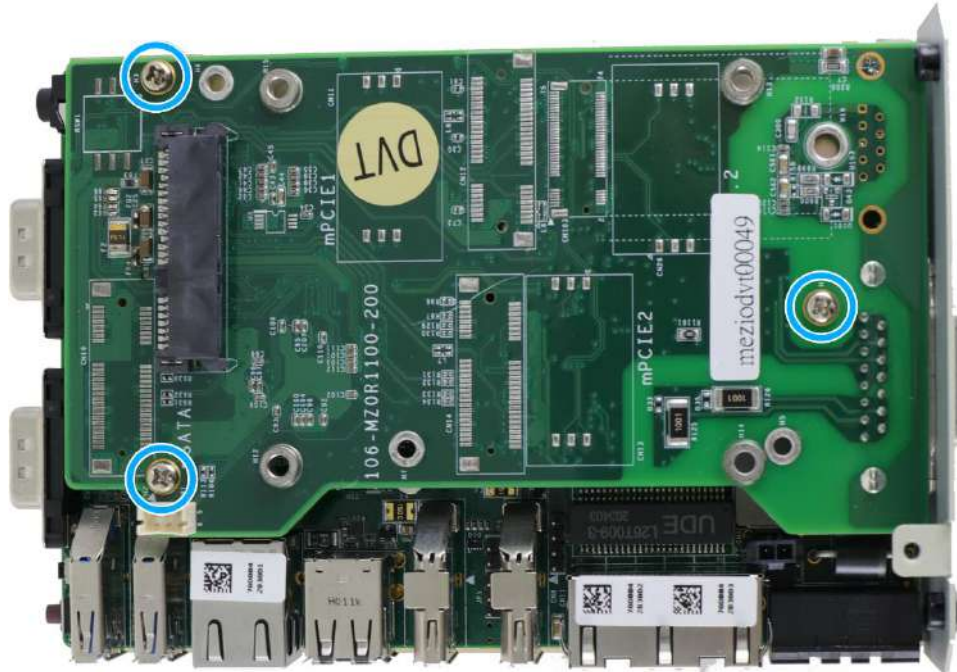

5. If you are installing a new MeziO™ module into your system, you may need to remove the punch-out plate depending on your MeziO expansion needs.

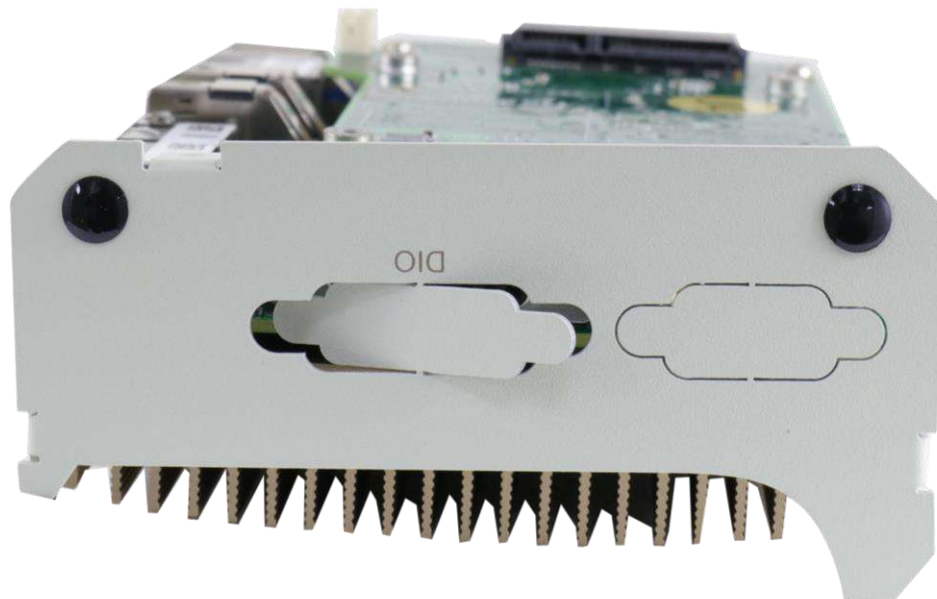

6. [Reinstall the system enclosure.](#)

### 3.3 Installing the System Enclosure

1. To reinstall the system enclosure, gently slide the L-shaped enclosure back in place making sure the screw hole on the hinge sits on the inside.

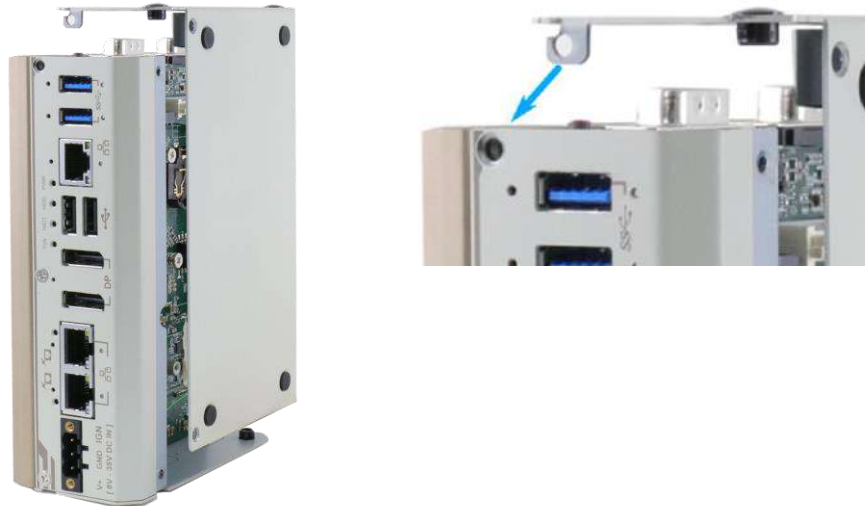

**Place enclosure back in-place    Make sure hinge sits on the inside**

2. Complete installing the system enclosure by fastening the screws indicated below.



**Front panel**

**Rear panel**



**Bottom of the enclosure**

### 3.4 DIN Rail Installation

The DIN rail is easy to install and it is a convenient way to position the system. The DIN rail has been proven to be most beneficial in the industrial environment where space is limited. The mount plate comes with two M4 screws. Please refer to the illustrations below to install the DIN clip/ rail.

1. To install, secure the DIN rail clip onto the rear of the system enclosure using the M4 screws provided.





2. To install the mount plate onto the DIN rail, you must come over the top of the DIN rail, tilting downwards, overlap the top clip edge of the mount plate onto the DIN rail first, then firmly press the bottom-front of the enclosure to clip the bottom edge of the mount plate.

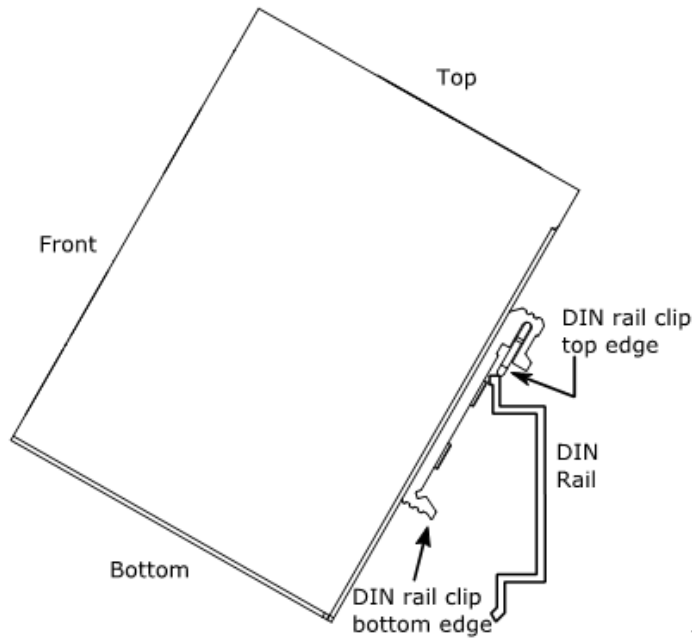

3. Confirm the mount plate has indeed clipped onto the DIN rail for proper fit to complete the installation.



### 3.5 Wall Mount Installation (Optional Accessory)

#### 3.5.1 Standard Wall Mount (Optional Accessory)

The optional wall mount bracket allows the system to be mounted horizontally. Please refer to the following installation procedure to install the wall mount.

1. To install, secure the wall mount bracket to the bottom of the system enclosure using the M4 screws provided.

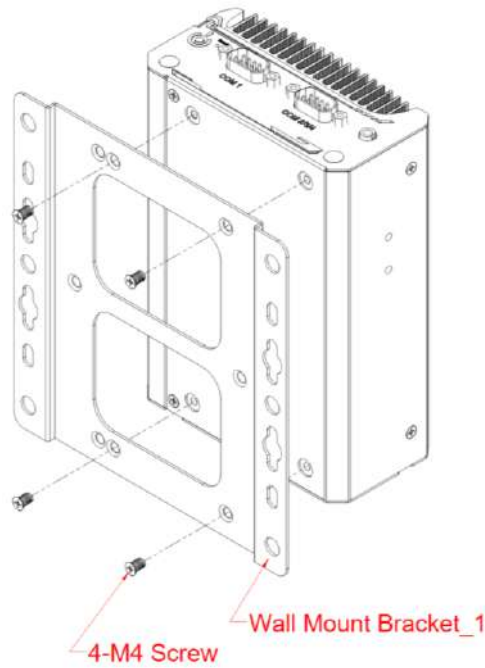

2. Dimension illustration of the installed wall mount bracket for your reference.

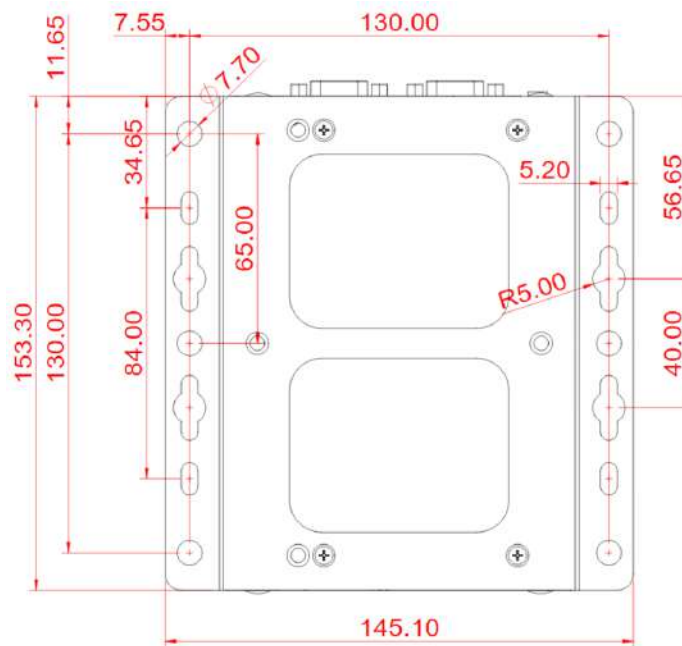

### 3.5.2 Vertical Wall Mount (Optional Accessory)

- To install, secure the wall mount bracket to the rear side panel of the system enclosure using the M4 screws provided.

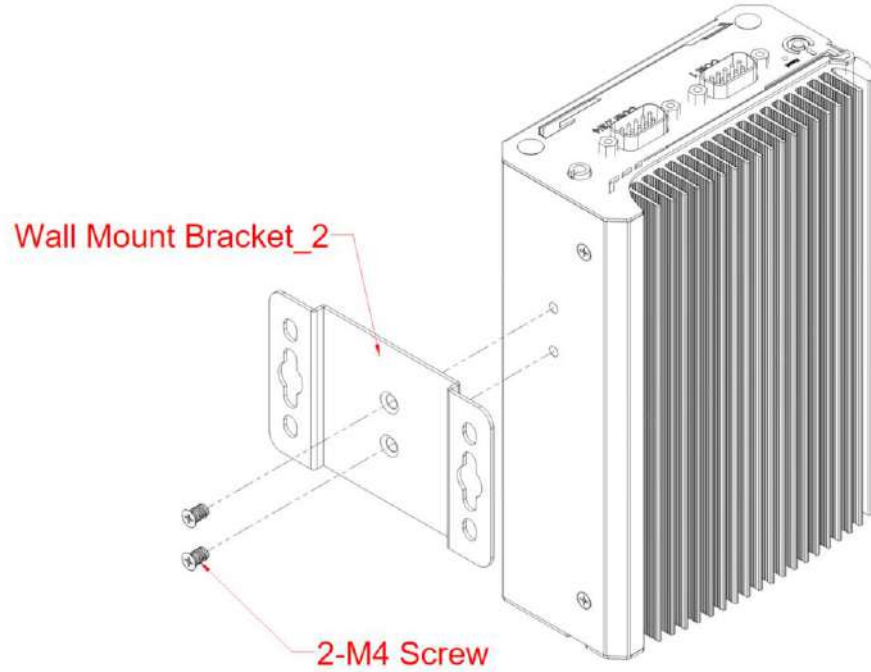

- Dimension illustration of the install vertical wall mount bracket for your reference.

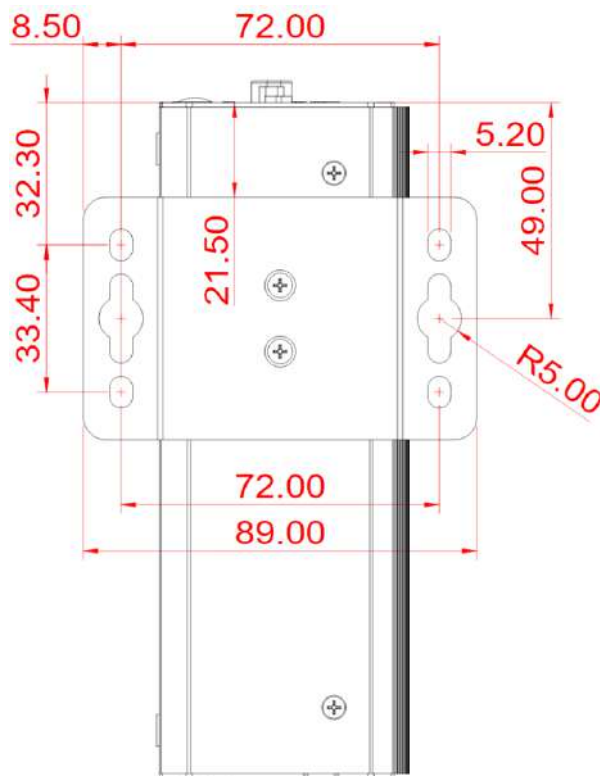

### 3.6 Powering On the System

There are five methods to power on the system

- Pressing the power button
- Via an external non-latched switch
- Sending a LAN packet via Ethernet (Wake-on-LAN)
- Using the ignition signal input (if MezIO-V20 is installed)

We will describe the processes and actions involved for the first four methods in this section and the ignition signal input method will be described in section 3.7.

#### 3.6.1 Powering On Using the Power Button

This is the simplest way to turn on your system. The power button on the front panel is a non-latched switch and behaves as the ATX-mode on/off control. With DC power connected, pushing the power button will turn on the system and the PWR LED indicator will light up. Pushing the button when system is on will turn off the system. If your operating system supports ATX power mode (i.e. Microsoft Windows or Linux), pushing the power button while the system is in operation will result in a pre-defined system behavior, such as shutdown or hibernation.

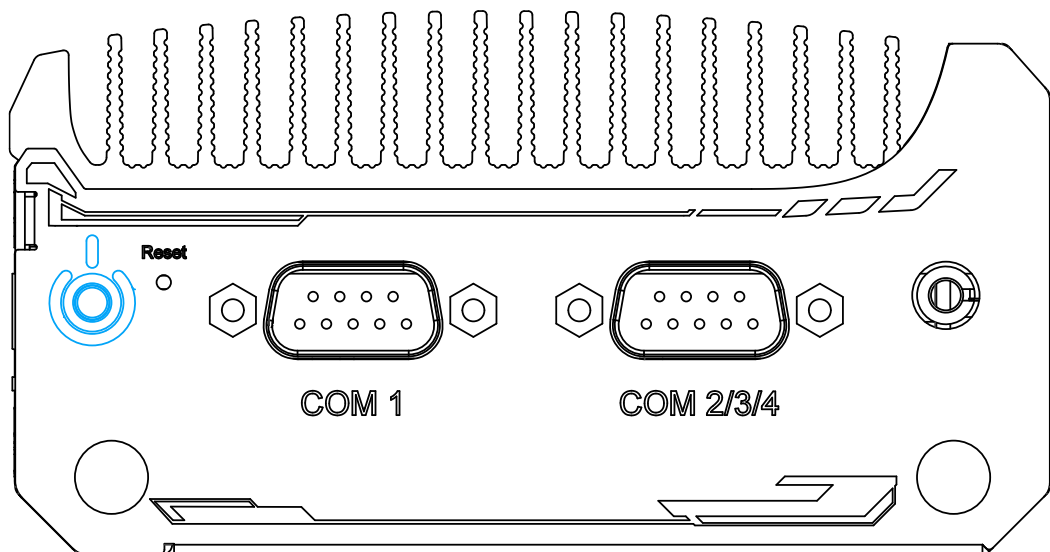

### 3.6.2 Powering On Using An External Non-Latched Switch

For an application which places the system inside a cabinet, it's useful to control powering on/off the system using an external switch. The system provides an on-board connector for connecting a latched/ non-latched switch and behaving either AT-mode or ATX-mode power on/off control.

When using the ATX-mode on/ off control, you need a non-latch switch. The external non-latched switch acts exactly the same as the power button on the front panel. Please follow the steps below to install an external non-latch switch.

1. Prepare a non-latched switch with a 2-pin, 2.0mm pitch connector

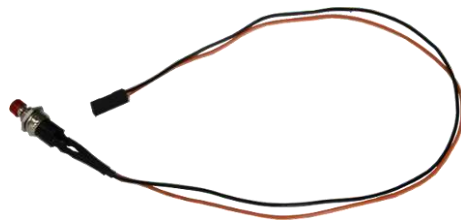

2. Connect the non-latched switch to the **pin#2** and **pin#3** of the on-board 1x3 pins, 2.0mm pitch pin header (polarity is negligible). Press the button on the switch to turn on the system.

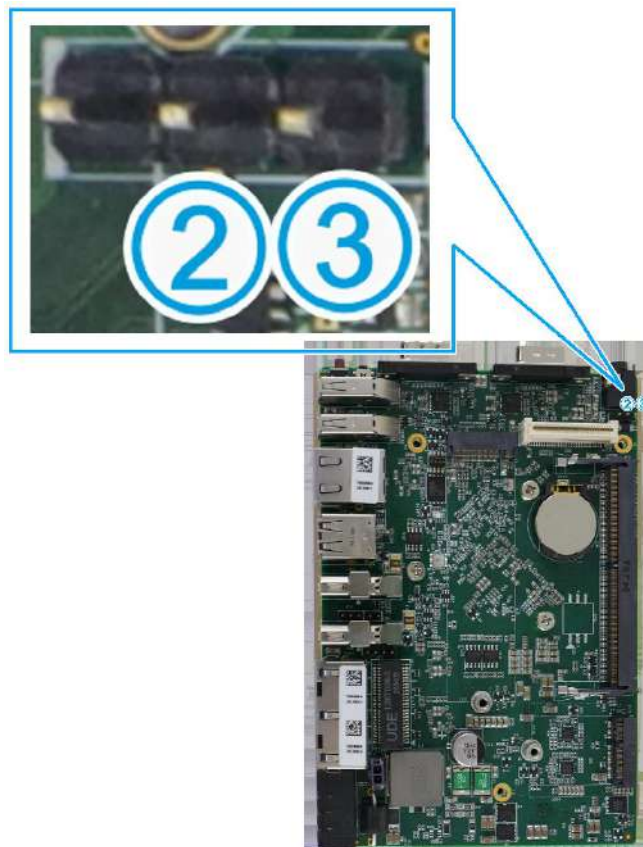

### 3.6.3 Powering On Using Wake-on-LAN

Wake-on-LAN (WOL) is a mechanism to wake up a computer system from a S3 (standby), S4 (Hibernate) or S5 (system off with standby power) state via issuing Subnet Directed Broadcasts (SDB) or a magic packet. The system implements the Wake-on-LAN function for the GbE port #1 shown below.

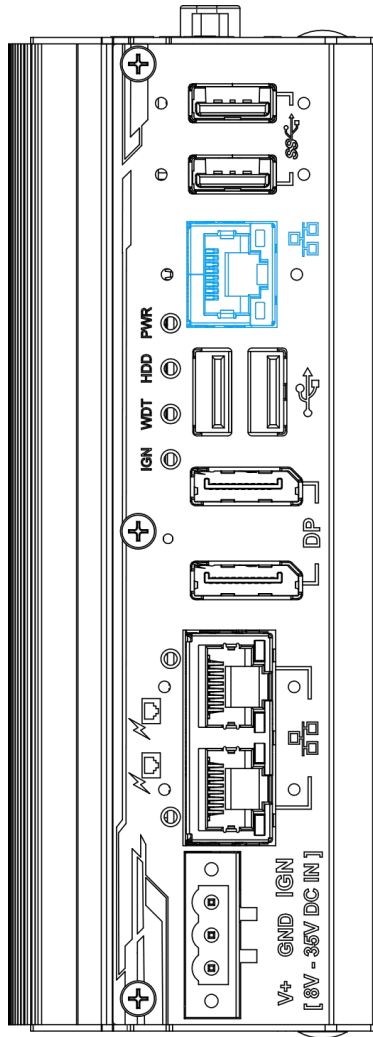

To enable WOL function and power on your system, please follow the steps below.

1. Press F2 when the system boots up to enter BIOS.
2. Enter the **[Power]** menu. And configure the **[Wake On LAN]** option as **[Enabled]**. Please refer to the [Wake-on-LAN](#) section.

- In Windows systems, identify the Local Area Connection of the corresponding Gigabit Controller and click the **Configure** button.

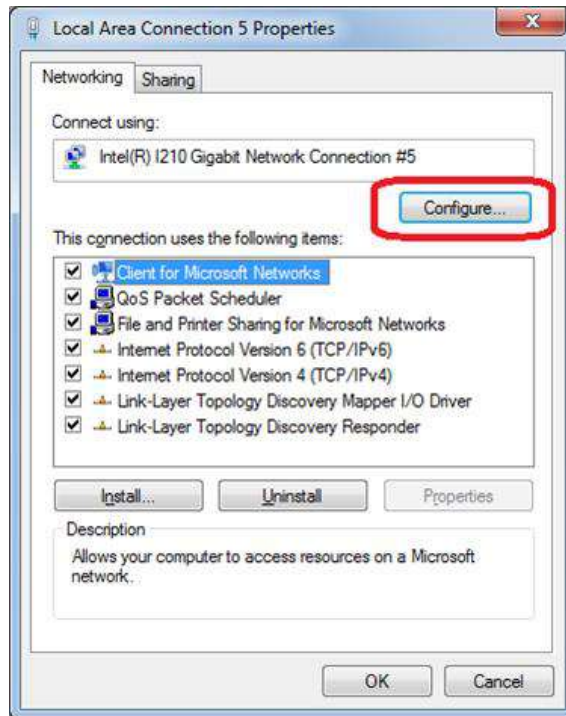

- Click the **Power Management** tag, and check the following two options accordingly

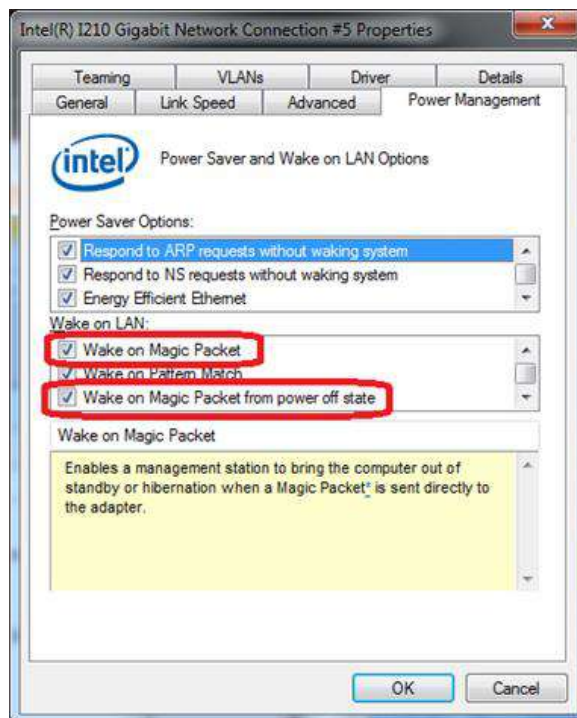

- **Wake on Magic Packet**

The system can wake from S3 or S4 state when receiving a magic packet. The magic packet is a broadcast frame containing anywhere within its payload 6 bytes of all 255 (FF FF FF FF FF FF in hexadecimal), followed by sixteen repetitions of the target computer's 48-bit MAC address.

For example, NIC's 48-bit MAC Address is 78h D0h 04h 0Ah 0Bh 0Ch

DESTINATION SOURCE MISC

FF FF FF FF FF FF

78 D0 04 0A 0B 0C 78 D0 04 0A 0B 0C

78 D0 04 0A 0B 0C 78 D0 04 0A 0B 0C

78 D0 04 0A 0B 0C 78 D0 04 0A 0B 0C

78 D0 04 0A 0B 0C 78 D0 04 0A 0B 0C

78 D0 04 0A 0B 0C 78 D0 04 0A 0B 0C

78 D0 04 0A 0B 0C 78 D0 04 0A 0B 0C

78 D0 04 0A 0B 0C 78 D0 04 0A 0B 0C

78 D0 04 0A 0B 0C 78 D0 04 0A 0B 0C

MISC CRC

There are some free tools available on Internet that can be used to send a magic packet. Please refer to the following link to understand more about Magic Packet.

<http://en.wikipedia.org/wiki/Wake-on-LAN>

- **Wake on Magic Packet from power off state**

When checking this option, the system can wake from S5 (system off with standby power) state when receiving a magic packet.



### 3.7 Ignition Power Control (For MezIO-V20 Only)

The ignition power control module for in-vehicle applications is a MCU-based implementation that monitors the ignition signal and reacts to turn on/off the system according to predefined on/off delay. Its built-in algorithm supports other features such as ultra-low power standby, battery-low protection, system hard-off, etc. In this section, we'll illustrate the principle of ignition power control and operation modes.

#### 3.7.1 Principles of Ignition Power Control

The basic concept of ignition power control module is to control the timing correlation between ignition signal and system power status. A typical timing correlation is described in following diagram.

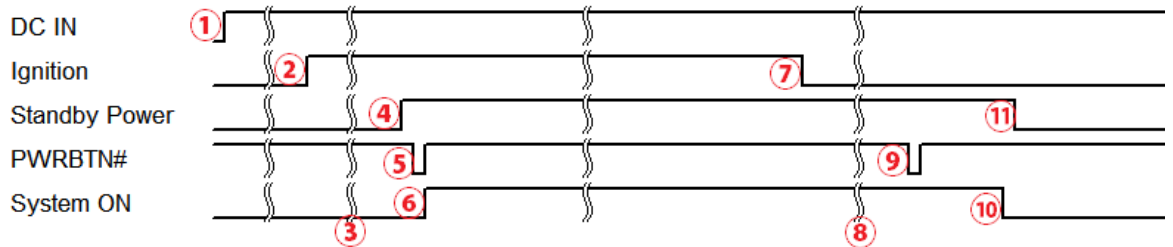

1. When DC power is supplied to the system, MCU starts to periodically detect ignition signal. Note that only MCU is working at this moment and the overall power consumption is less than 2 mW.
2. Ignition signal is active (both 12VDC and 24VDC ignition signals are accepted).
3. MCU starts to count a pre-defined power-on delay.
4. Once power-on delay expired, MCU turns on necessary standby power for the system (3.3VSB & 5VSB).
5. A PWRBTN# pulse is then issued to turn on the system (equivalent to one pressing the power button on the front panel).
6. The system is booting and becomes operational.
7. After a period of time, the ignition signal becomes inactive.
8. MCU starts to count a pre-defined power-off delay.
9. Once power-off delay expired, another PWRBTN# pulse is issued to perform a soft-off for the system (ex. a normal shutdown process for Windows system).
10. The system is completely shut down.
11. As MCU detects system is off, it turns off the standby power for the system, and operates in low power mode again (< 2mW power consumption).

### 3.7.2 Additional Features of Ignition Power Control

In addition to the typical timing correlation, the ignition power control module offers additional features to provide additional reliability for in-vehicle applications.

- **Low battery detection**

The ignition power control module continuously monitors the voltage of DC input when the system is operational. If input voltage is less than 9V (for 12VDC input) or less than 18V (for 24VDC input) over a 60-second duration, it will shut down the system automatically.

- **Guarded power-on/ power-off delay duration**

If ignition signal goes inactive during the power-on delay duration, the ignition power control module will cancel the power-on delay process and go back to idle status. Likewise if ignition signal goes active during the power-off delay duration, the ignition power control module will cancel the power-off delay process and keep the system running.

- **System hard-off**

In some cases, system may fail to shutdown via a soft-off operation due to system/ application halts. The ignition power control module offers a mechanism called “hard-off” to handle this unexpected condition. By detecting the system status, it can determine whether the system is shutting down normally. If not, the ignition power control module will force cut-off the system power 10 minutes after the power-off delay duration.

- **Smart off-delay**

The ignition power control module offers two modes (mode 6 & mode 7) which have very long power-off delay duration for applications require additional off-line time to process after the vehicle has stopped. In these two modes, the ignition power control module will automatically detect the system status during the power-off delay duration. If the system has shutdown (by the application software) prior to power-off delay expiring, it will cut off the system power immediately to prevent further battery consumption.

### 3.7.3 Wiring Ignition Signal

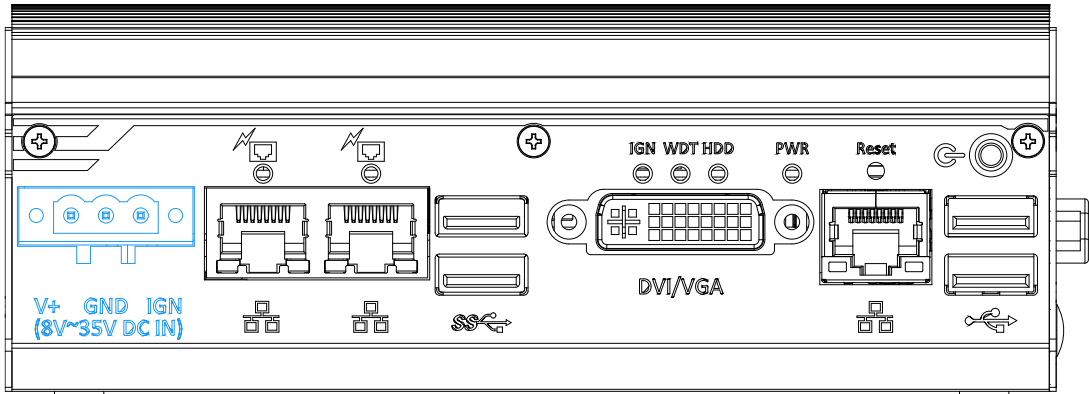

To have ignition power control for in-vehicle usage, you need to supply IGN signal to the system. The IGN input is located on the 3-pin pluggable terminal block (shared with DC power input). For in-vehicle ignition control wiring, please do the following:

1. Connect car Battery+ line (12V for sedan, 24V for bus/truck) to V+.
2. Connect car Batter-/ GND line to GND.
3. Connect ACC line to IGN.



**WARNING**

*Please make sure your DC power source and IGN signal share the same ground. IGN input accepts 8~35VDC. Supply a voltage higher than 35VDC may damage the system.*

### 3.7.4 Configure your Windows system

When applying ignition power control to your system, please make sure you've configured your Windows system to initiate a shutdown process when pressing the power button. By default, Windows 7/ 8/ 10 goes to sleep (S3) mode when power button is pressed. As sleep (S3) is not a complete shutdown behavior, the ignition control function does not recognize the finish of a normal shut down process and thus users will encounter a system hard-off (power cut-off after 10 minutes). Please configure "When I press the power button" to "Shut down" in your Windows system settings.

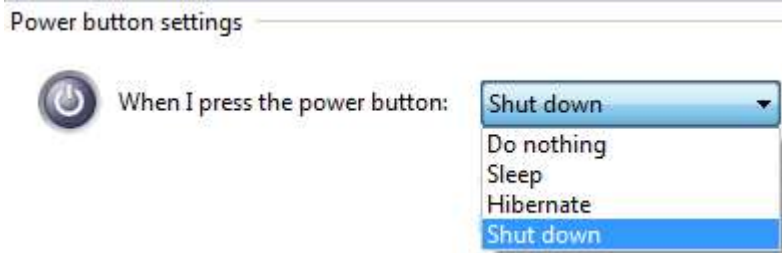

### 3.7.5 Operation Modes of Ignition Power Control

You can use the rotary switch to configure the operation mode. The system offers 16 (0~15) operation modes with different power-on/power-off delay configurations.

The ignition control module is also BIOS-configurable. When rotary switch is set to mode 15 (0xF), the ignition power control is set to executed according to parameters configured in BIOS setup menu, which allows richer combination of power-on/power-off delay and more detailed control parameters.

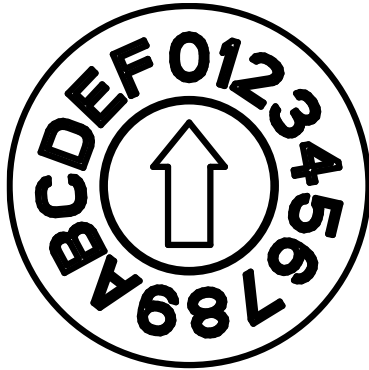

#### Ignition rotary switch

- **Mode 0**

Mode 0 is the ATX mode without power-on and power-off delay. User can only use the power button on the front panel to turn on or turn off the system.

Mode	Power-on Delay	Power-off Delay	Hard-off Timeout
0	N/A	N/A	N/A

- **Mode 1**

Mode 1 is AT mode without power-on and power-off delay. The system automatically turns on when DC power is applied. A retry mechanism is designed to repeat the power-on cycle if the system fails to boot up.

Mode	Power-on Delay	Power-off Delay	Hard-off Timeout
1	N/A	N/A	N/A

- **Mode 2**

Mode 2 is designed to have a very minor power on/ off delay of 160ms for applications that requires the system to start up almost at the same as the rest of the equipment it is working in collaboration with.

Mode	Power-on Delay	Power-off Delay	Hard-off Timeout
2	160ms	160ms	10 minutes

- **Mode 3 ~ Mode 12**

Mode 3 ~ Mode 12 have various power-on delay and power-off delay. Each mode supports a hard-off timeout of 10 minutes.

Mode	Power-on Delay	Power-off Delay	Hard-off Timeout
3	10 seconds	10 seconds	10 minutes
4	10 seconds	1 minute	10 minutes
5	10 seconds	5 minutes	10 minutes
6	30 seconds	1 minute	10 minutes
7	30 seconds	5 minutes	10 minutes
8	30 seconds	10 minutes	10 minutes
9	3 minutes	1 minute	10 minutes
10 (A)	3 minutes	10 minutes	10 minutes
11 (B)	3 minutes	30 minutes	10 minutes
12 (C)	10 minutes	30 minutes	10 minutes

- **Mode 13 (D) / Mode 14 (E)**

Mode 13 and Mode 14 are ignition power control modes with very long power-off delay. Both modes support the feature of “smart off-delay”, which automatically detect system status during power-off delay duration and cut off system power if system is off in prior to power-off delay expired.

Mode	Power-on Delay	Power-off Delay	Hard-off Timeout
13 (D)	30 seconds	2 hours	10 minutes
14 (E)	3 minutes	2 hours	10 minutes

- **Mode 15 (F)**

Mode 15 is reserved for manufacturer purposes.

# 4 BIOS Settings

The system is shipped with factory-default BIOS settings optimized for best performance and compatibility. In this section, we'll illustrate some BIOS settings you may need to set or change prior to operating system installation. Please always make sure you understand the effect of change before you proceed with any changes. If you are unsure of the function you are changing, it is recommended to change one setting at a time to see its effect(s).

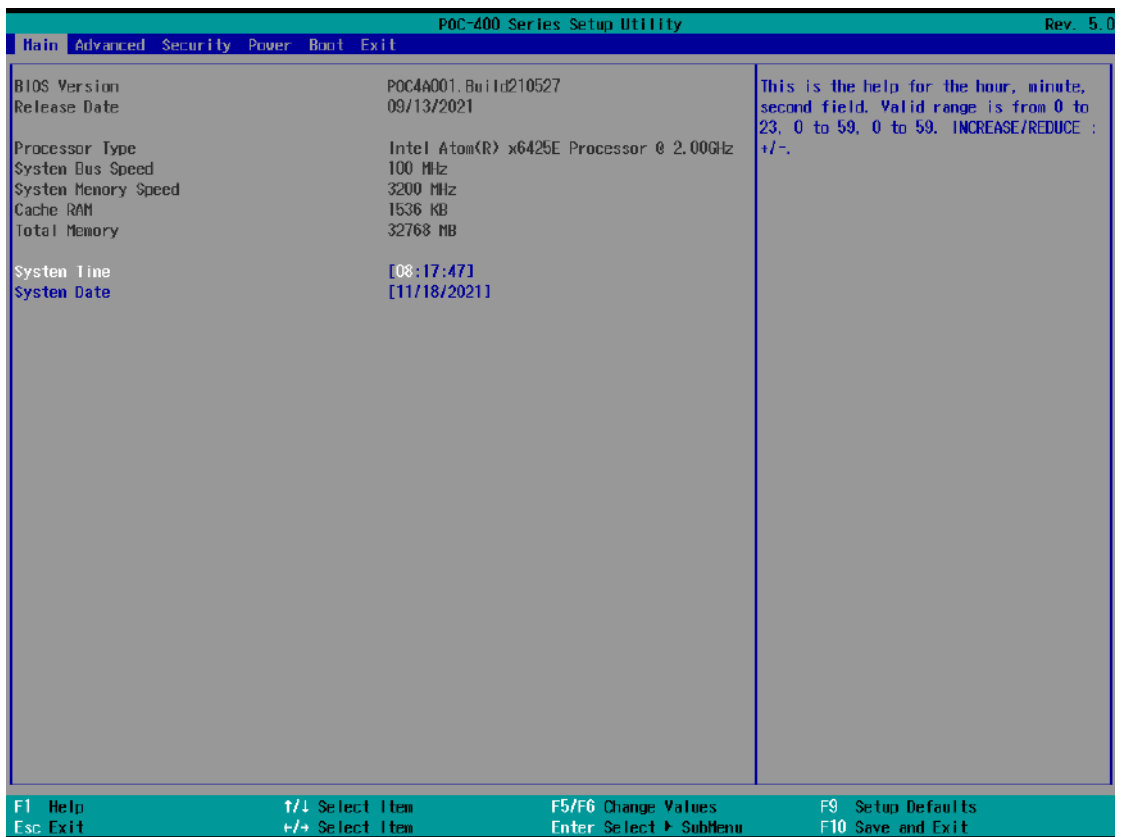

## 4.1 COM1 Port Configuration

The system's [COM1 port](#) supports RS-232 (full-duplex), RS-422 (full-duplex) and RS-485 (half-duplex) mode. You can set the COM1 operating mode via BIOS settings. Another option in BIOS called “*Slew Rate*” defines how sharp the rising/falling edge is for the output signal of COM1. For long-distance RS-422/485 transmission, you may set the “*Slew Rate*” option as “High” to improve signal quality. For RS-422/485 communication, the “*RS-422/485 Termination*” option determines whether to enable/disable internal termination of RS-422/485 transceiver according to your wiring configuration (e.g. with or without external termination).

### To set COM1 operating mode:

1. Press **F2** when the system boots up to enter the BIOS setup utility.
2. Go to **[Advanced]** → **[Peripheral Configuration]**.
3. Set the **[Set COM1 Mode as]** option to the desired mode.
4. Once set, press **F10** to save setting and exit.

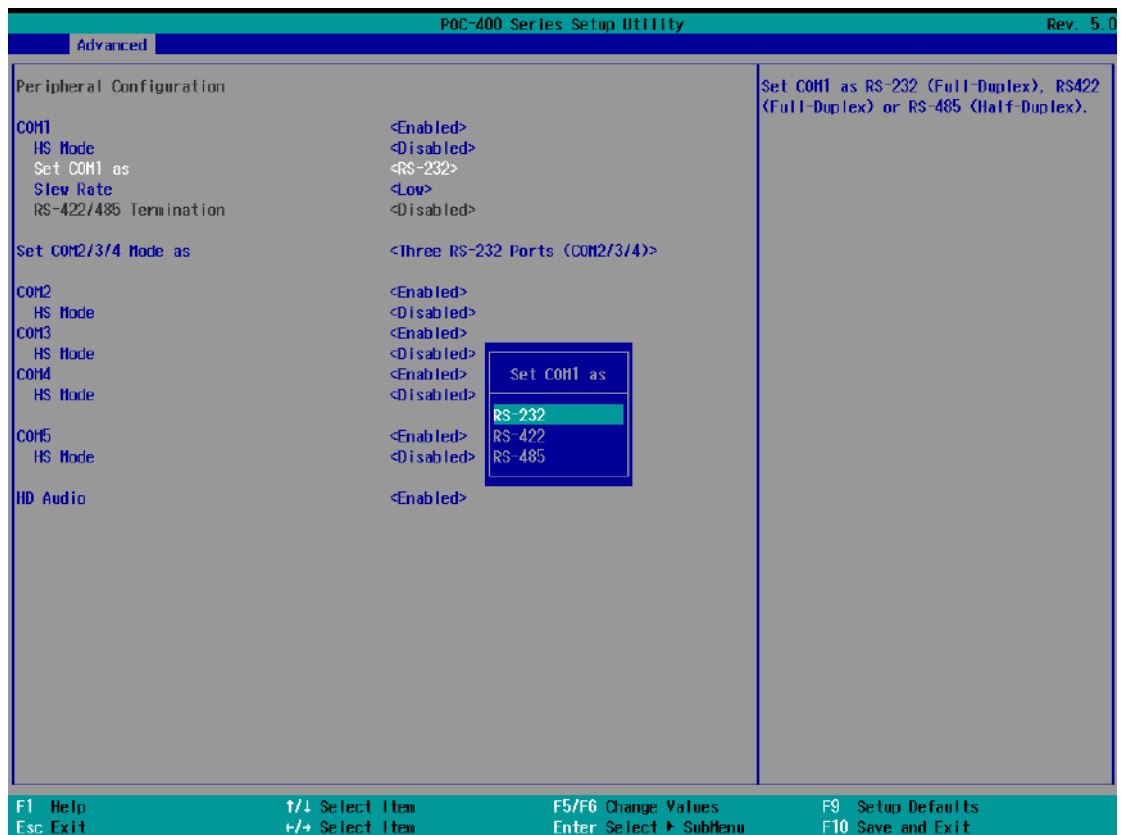



## 4.2 COM2/ 3/ 4 Port Configuration

The system's [COM2/ 3/ 4 ports](#) support RS-232 (full-duplex) while COM2 also supports RS-422 (full-duplex) and RS-485 (half-duplex) mode. The operating mode can be configured via the BIOS. Another option in BIOS called “Slew Rate” defines how sharp the rising/falling edge is for the output signal. For long-distance RS-422/485 transmission, you may set the “Slew Rate” option as “High” to improve signal quality. For RS-422/485 communication, the “RS-422/485 Termination” option determines whether to enable/disable internal termination of RS-422/485 transceiver according to your wiring configuration (e.g. with or without external termination).

### To set COM2/ 3/ 4 operating mode:

1. Press **F2** when the system boots up to enter the BIOS setup utility.
2. Go to **[Advanced]** → **[Peripheral Configuration]**.
3. Set the **[Set COM2/ 3/ 4 Mode as]** option to the desired mode.
4. Once set, press **F10** to save setting and exit.

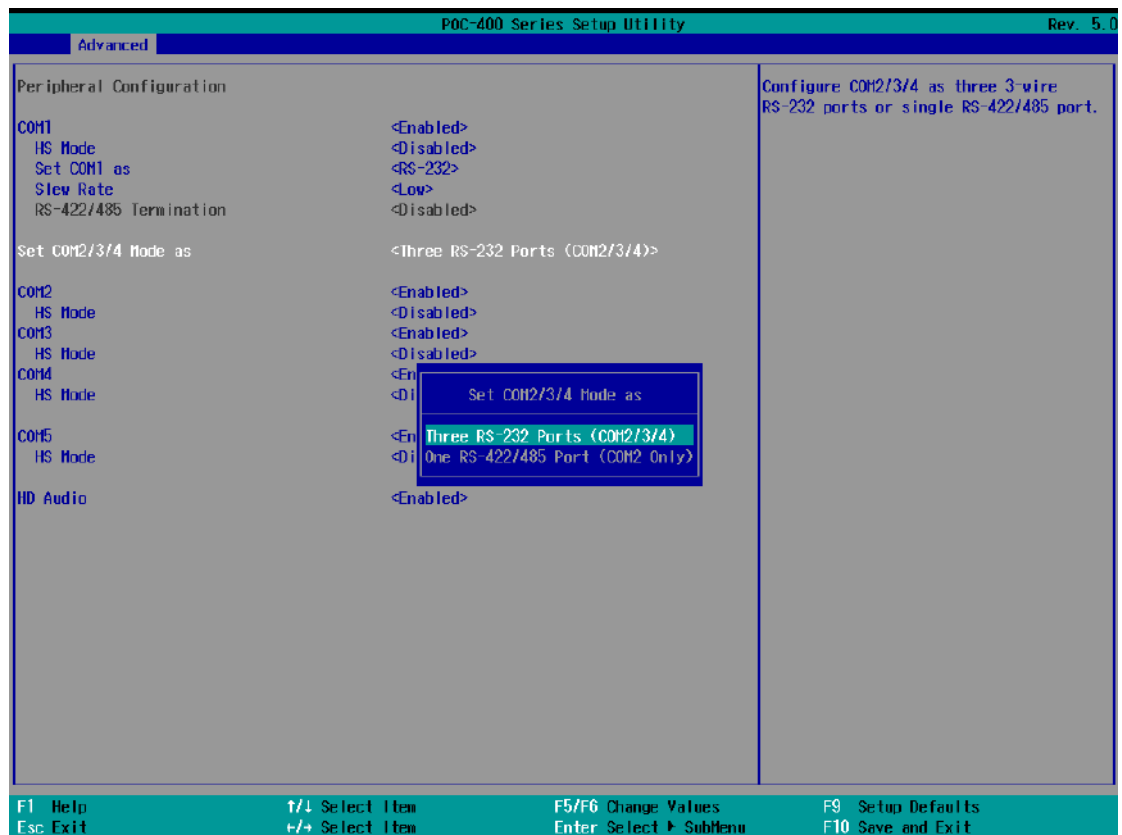

### 4.3 C-States

C-States is a power-saving technique implemented in modern Intel processors. It shuts down the clock signals and power for idle logic units inside the CPU to save the energy consumed. The trade-off, however, is a longer latency for CPU to wake up and be 100% operational. Depending on your application, you can configure these options to have higher performance (disable “C-States”) or lower power-consumption (enable “C-States”).

**To set C-States and Enhanced C-States:**

1. Press **F2** when the system boots up to enter the BIOS setup utility.
2. Go to **[Power] → [CPU Configuration] → [CPU Power Management]**
3. Enable/disable the **[C-States]** option according to your application.
4. Once set, press **F10** to save setting and exit.

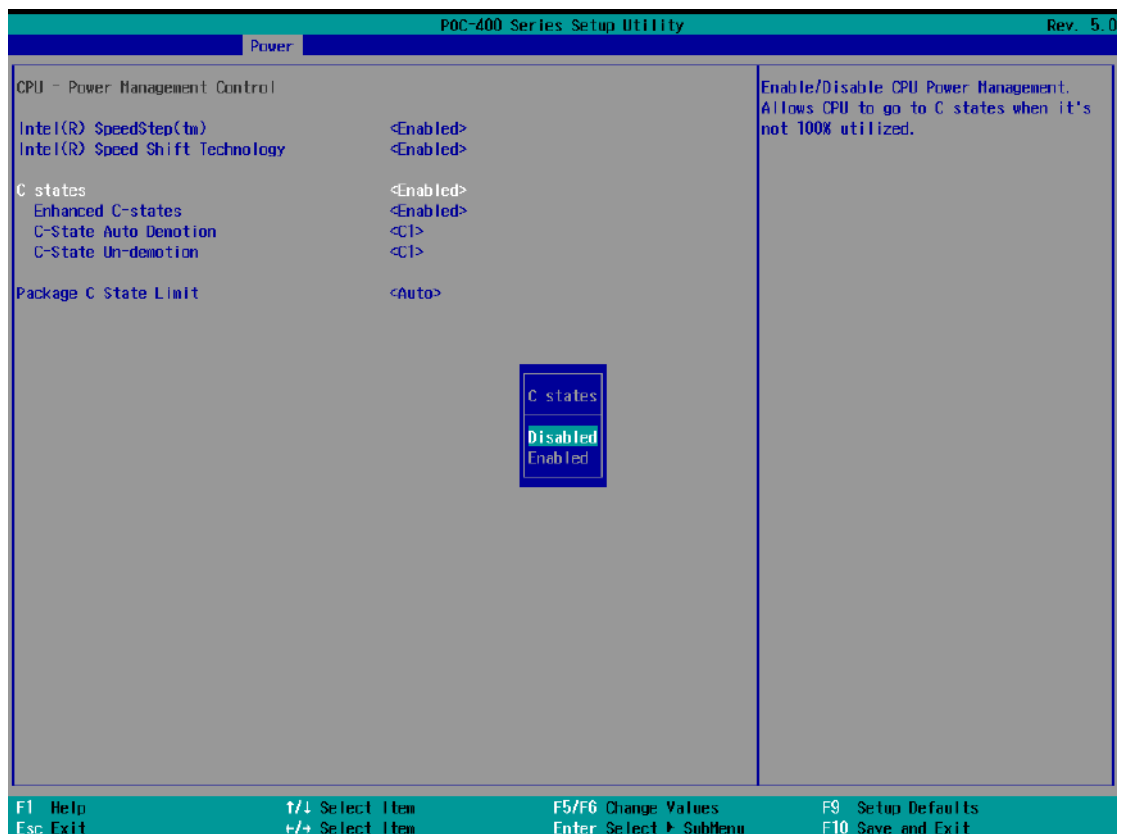

## 4.4 Power over Ethernet (POC-400 Only)

The Power over Ethernet (PoE) functionality is available on ports 1 and 2, and it allows for the transmission of data and power delivery while utilizing a single Cat5 and higher grade Ethernet cable.

## 4.5 Wake-on-LAN

Wake-on-LAN (WOL) is a mechanism which allows you to turn on your system via Ethernet connection. To utilize Wake-on-LAN function, you have to enable this option first in BIOS settings. Please refer to Powering on via Wake-on-LAN function.

**To enable/disable “Wake on LAN” option:**

1. Press **F2** when the system boots up to enter the BIOS setup utility.
2. Go to **[Power]**.
3. You may enable/disable the **[Wake on LAN]** option.
4. Once set, press **F10** to save setting and exit.

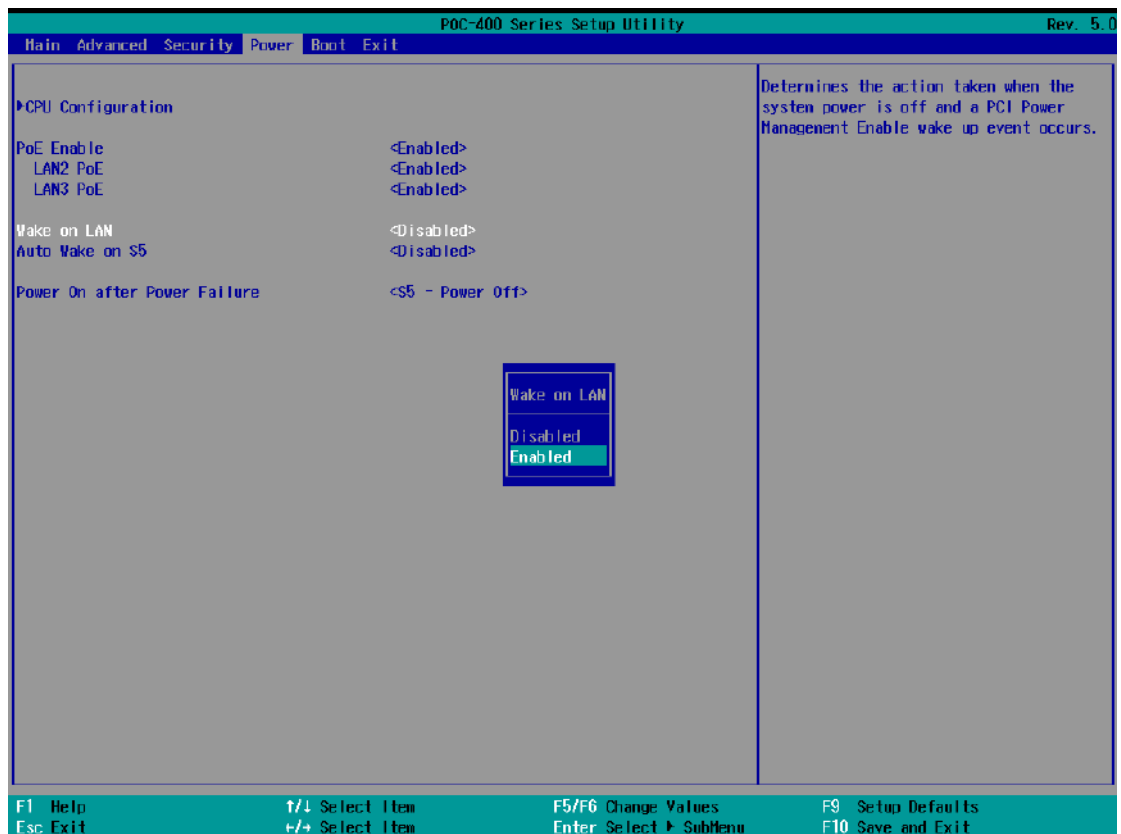

## 4.6 Power On after Power Failure

This option defines the system's behavior when DC power is supplied.

Value	Description
S0 – Power On	System is powered on when DC power is supplied.
S5 – Power Off	System is kept in off state when DC power is supplied.

When you want to use the AT-mode remote on/off control function, you have to set this option to “S0 – Power On”. Please refer to [section 3.7.2](#) for instructions of using AT-mode remote on/off control function.

### To set “Power On after Power Failure” option:

1. Press **F2** when the system boots up to enter the BIOS setup utility.
2. Go to **[Power]**.
3. Set the **[Power On after Power Failure]** option to the desired setting.
4. Once set, press **F10** to save setting and exit.

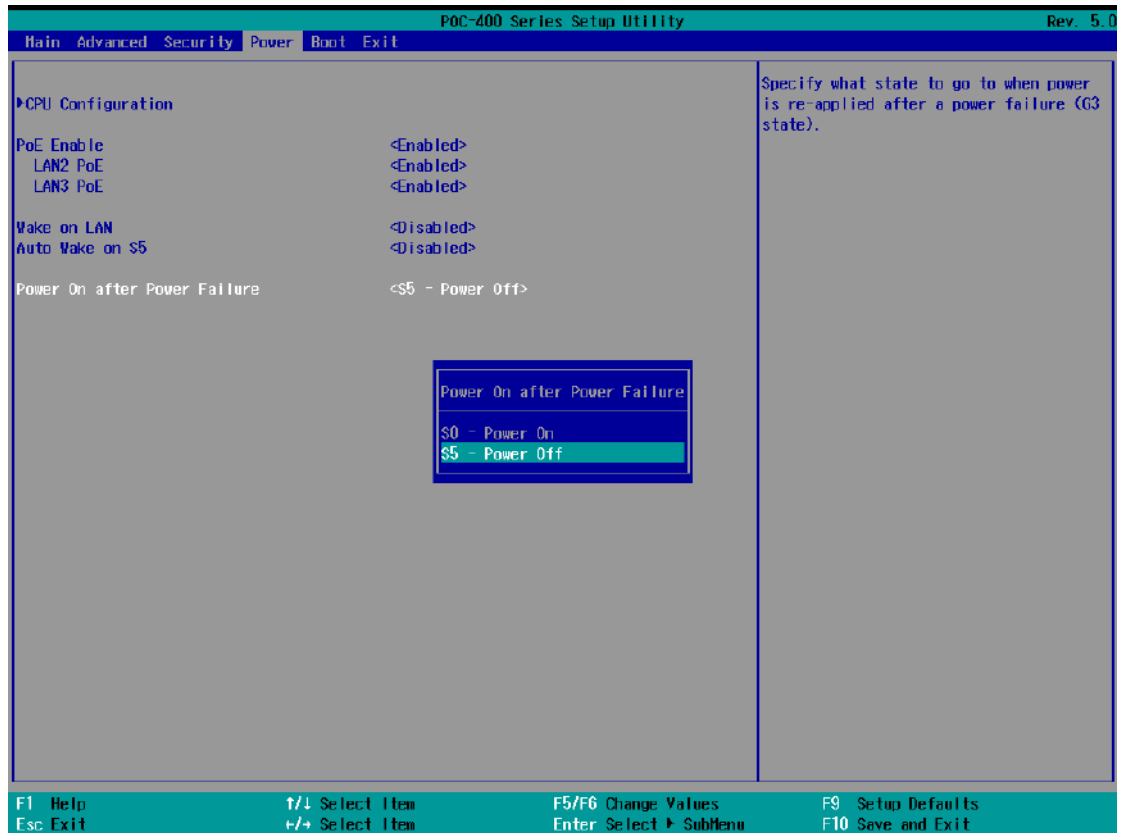

## 4.7 Position New Boot Device

The “Add Boot Options” allow you to determine whether a newly added device (eg. USB flash disk) is to boot as the first device to boot or the last in the boot sequence.

To set the newly-installed boot device as the first or last boot device:

1. Press **F2** when the system boots up to enter the BIOS setup utility.
2. Go to **[Boot] > [Add Boot Options]** menu.
3. Select **[First]** or **[Last]** for your newly-added boot device and press Enter.
4. Once set, press **F10** to save setting and exit.

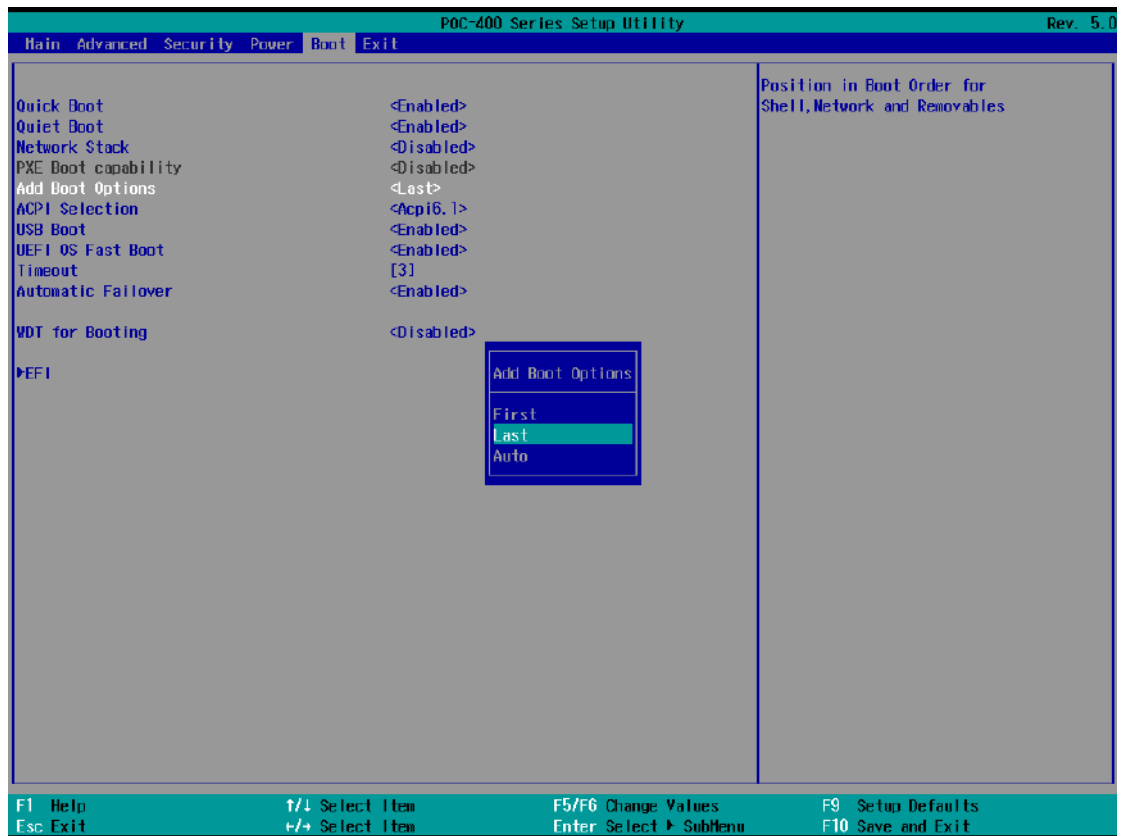

## 4.8 Watchdog Timer

The watchdog timer secures the boot process by means of a timer. Once the timer expires, a reset command is issued to initiate another booting process. There are two options in BIOS menu, “*Automatically after POST*” and “*Manually after Entering OS*”. When “*Automatically after POST*” is selected, the BIOS automatically stops the watchdog timer after POST (Power-On Self Test) OK. When “*Manually after Entering OS*” is selected, the user must stop the watchdog timer once booted into the OS. This guarantees the system can always boot into the OS, otherwise another booting process will be initiated. For information about programming watchdog timer, please refer to [Appendix A Using WDT & DIO](#).

To set the watchdog timer for boot in BIOS:

1. Press **F2** when the system boots up to enter the BIOS setup utility.
2. Go to **[Boot]** menu.
3. Disable or select timeout value for **[WDT for Booting]** option.
4. Once you set a timeout value, the **[WDT Stop Option]** option appears. You can select either “*Automatically after POST*” or “*Manually after Entering OS*”.
5. Once set, press **F10** to save setting and exit.

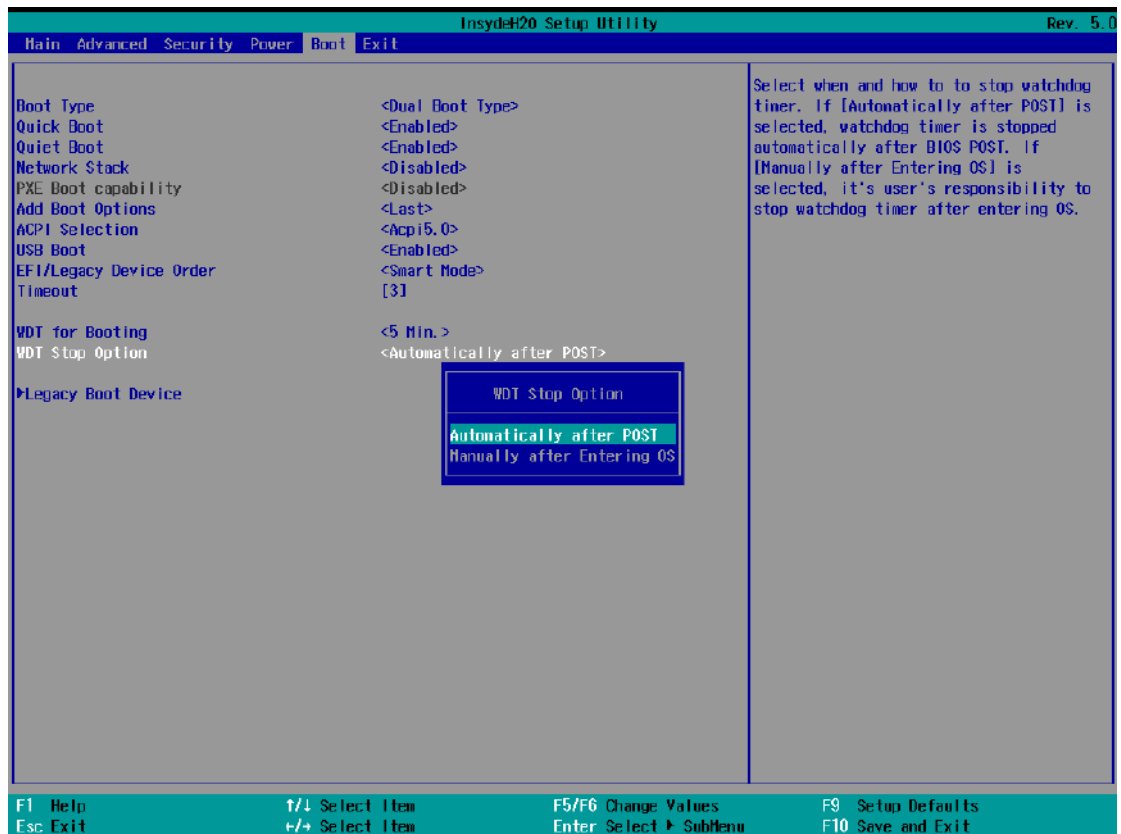

## 5 OS Support and Driver Installation

### 5.1 Operating System Compatibility

Due to Intel's policy, POC-400 series only provide driver support for the following operating systems. The following list contains the operating systems which have been tested in Neosys Technology Inc.

- Microsoft Windows 10 Enterprise LTSC 2019 64-bit
- Microsoft Windows 11 IoT Enterprise 22H2 64-bit
- Ubuntu 20.04.2 LTS\*\* or other distribution with kernel  $\geq 5.8$  \*/\*\*



#### NOTE

*\*For Linux system, user may need to manually compile and install the driver for Intel graphics or I225 controller if the driver is not embedded in kernel. You can visit Intel website for further information.*

*\*\*For distributions, graphics driver may not be completely implemented in its kernel. You may encounter restrictions when using these features, such as multiple independent displays. For optimum operation, it is the users' responsibility to manually check for new drivers and upgrades!*

Neosys may remove or update operating system compatibility without prior notice. Please contact us if your operating system of choice is not on the list.

## 5.2 Driver Installation

The system comes with a “Drivers & Utilities” DVD that offers “one-click” driver installation process. It automatically detects your Windows operating system and installs all necessary drivers for you system with a single click.

### 5.2.1 Install Drivers Automatically

To install drivers automatically, please refer to the following procedures.

1. Insert the “Drivers & Utilities” DVD into a USB DVD-drive connect to your system. A setup utility launches and the following dialog appears.



2. Click on “**Automatic Driver Installation**” and the setup utility will automatically detect your Windows operating system and install all necessary drivers. The installation process takes about 6~8 minutes depending on your Windows version. Once driver installation is done, the setup utility reboots your Windows and you may begin using your system.



## 5.2.2 Install Drivers Manually

You can also manually install each driver for the system. Please note when installing drivers manually, you need to install the drivers in the following sequence mentioned below.

### Windows 10 (x64)

The recommended driver installation sequence is

1. **Chipset driver** (x:\Driver\_Pool\Chipset\_ELK\Win\_10\_64\SetupChipset.exe)
2. **Graphics driver** (x:\Driver\_Pool\Graphics\_ELK\Win\_10\_64\igxpip.exe)
3. **Audio driver** (x:\Driver\_Pool\Audio\_ALC262\Win\_ALL\_64\Setup.exe)
4. **LAN driver**  
(x:\Driver\_Pool\GbE\_I210\_I225\_I350\_X550\Win\_10\_64\APPS\PROSETDX\Win\_10\_64\DxSetup.exe)
5. **TXE driver** (x:\Driver\_Pool\TXE\_ELK\Win\_10\_64\SetupME.exe)

## 5.3 Driver for Watchdog Timer and DIO

Neosys provides a driver package which contains function APIs for WDT function and isolated DIO control function (when MezIO-R12, D230 or D220 is installed). You should install the driver package (WDT\_DIO\_Setup.exe) in prior to use these functions. Please note that you must install WDT\_DIO\_Setup\_v2.3.1 or later versions.



### **NOTE**

Please install WDT\_DIO\_Setup\_v2.3.1 or later versions.

#### **Windows 10 (x64)**

Please execute the driver setup program in the following directory.

x:\Driver\_Pool\WDT\_DIO\Win7\_8\_10\_64\WDT\_DIO\_Setup\_v2.3.1(x64).exe

#### **Windows 10 (WOW64)**

Please execute the driver setup program in the following directory.

x:\Driver\_Pool\WDT\_DIO\Win7\_8\_10\_WOW64\WDT\_DIO\_Setup\_v2.3.1(wow64).exe

# Appendix A Using WDT & DIO

The watchdog timer (WDT) function to ensure reliable system operation. The WDT is a hardware mechanism to reset the system if the watchdog timer is expired. Users can start the WDT and keeping resetting the timer to make sure the system or program is running. Otherwise, the system shall be reset.

In this section, we'll illustrate how to use the function library provided by Neosys to program the WDT functions. Currently, WDT driver library supports Windows 10 x64 and WOW64 platform. For other OS support, please contact Neosys Technology for further information.

## Installing WDT\_DIO Library

The WDT\_DIO function library is delivered in the form of a setup package named **WDT\_DIO\_Setup.exe**. In prior to program WDT, you should execute the setup program and install the WDT library. Please use the following WDT\_DIO\_Setup packages according to your operating systems and application.

- For Windows 10 64-bit OS with 64-bit application (x64 mode), please install WDT\_DIO\_Setup\_v2.3.1(x64).exe or later version.
- For Windows 10 64-bit OS with 32-bit application (WOW64 mode), please install WDT\_DIO\_Setup\_v2.3.1(wow64).exe or later version.

## WDT and DIO Library Installation

To setup WDT & DIO Library, please follow instructions below.

1. Execute **WDT\_DIO\_Setup.2.3.1.exe**. and the following dialog appears.

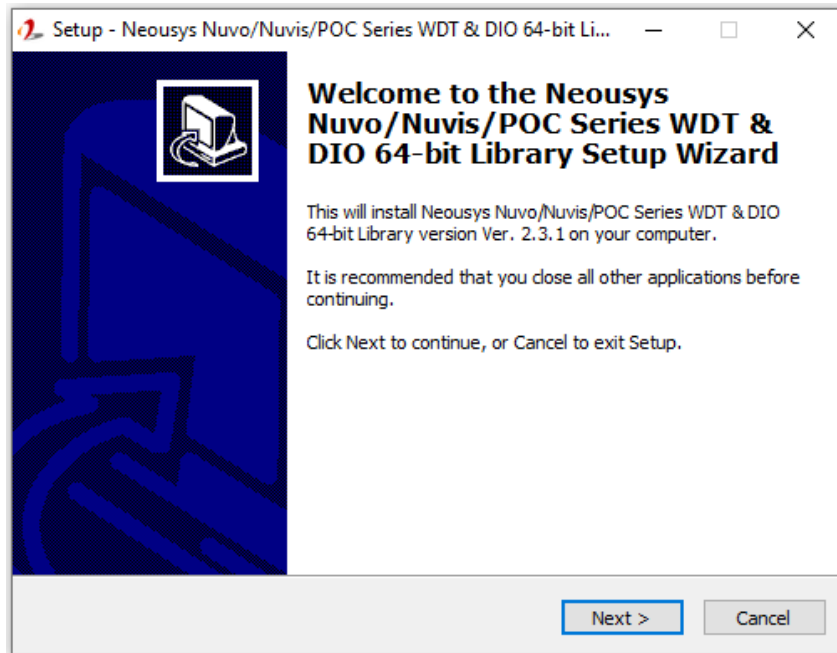

2. Click "Next >" and specify the directory of installing related files. The default directory is *C:\Neosys\WDT\_DIO*.

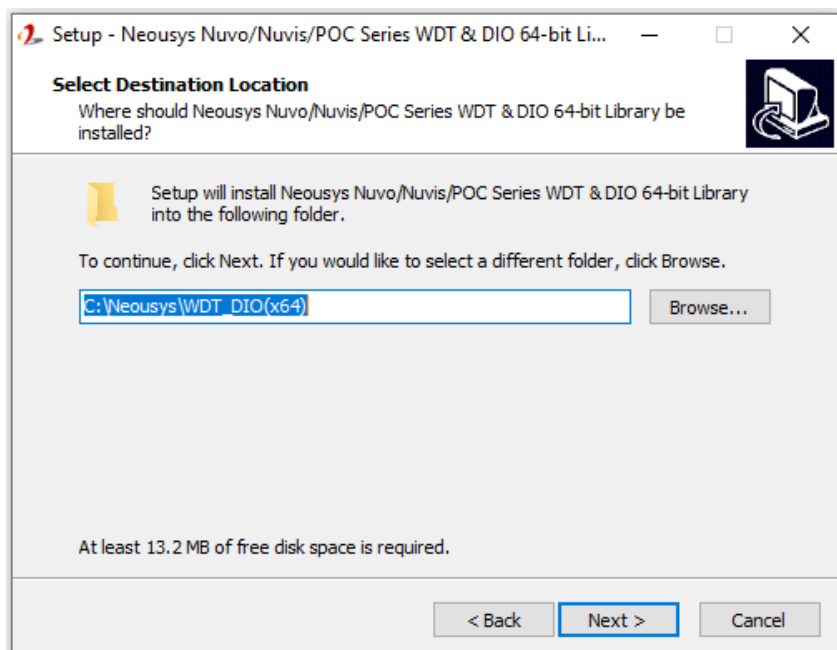

- Once the installation has finished, a dialog will appear to prompt you to reboot the system. The WDT & DIO library will take effect after the system has rebooted.

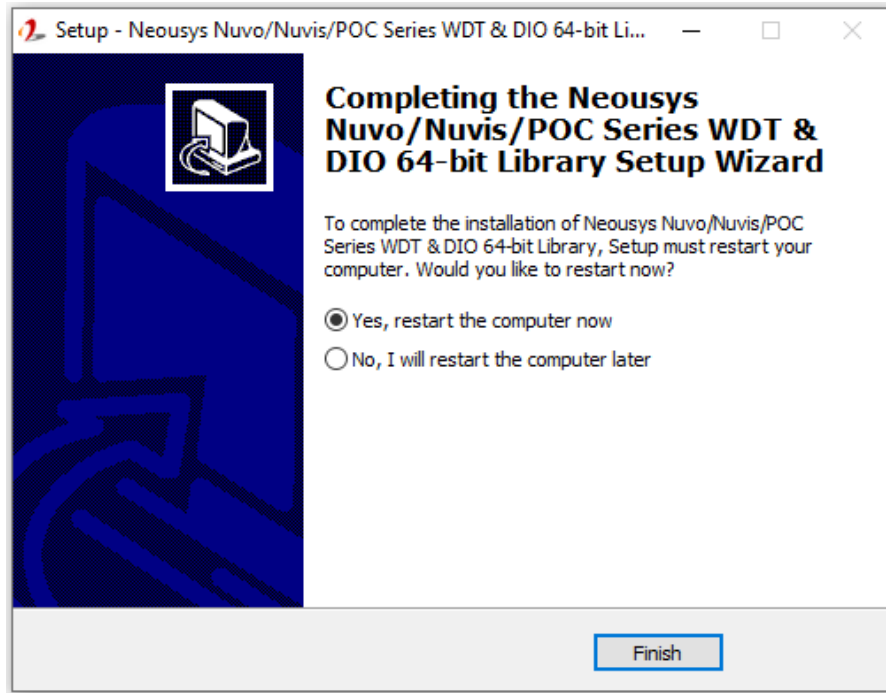

- When programming your WDT or DIO program, the related files are located in

<b>Header File:</b>	\Include
<b>Library File:</b>	\Lib
<b>Function Reference:</b>	\Manual
<b>Sample Code:</b>	\Sample\WDT_Demo (Demo for Watchdog Timer) \Sample\DIO_Demo (Demo for isolated DIO Control) \Sample\COS_Demo (Demo for change-of-state DI)

## WDT Function Reference

### InitWDT

<b>Syntax</b>	BOOL InitWDT(void);
<b>Description:</b>	Initialize the WDT function. You should always invoke InitWDT() before set or start watchdog timer.
<b>Parameter</b>	None
<b>Return Value</b>	<b>TRUE:</b> Successfully initialized <b>FALSE:</b> Failed to initialize
<b>Usage</b>	BOOL    bRet = InitWDT()

### SetWDT

<b>Syntax</b>	BOOL SetWDT(WORD tick, BYTE unit);
<b>Description</b>	Set timeout value and unit for watchdog timer. When InitWDT() is invoked, a default timeout value of 255 seconds is assigned.
<b>Parameter</b>	<i>tick</i> WORD value (1 ~ 65535) to indicate timeout ticks. <i>unit</i> BYTE value (0 or 1) to indicate unit of timeout ticks. 0 : unit is minute 1: unit is second
<b>Return Value</b>	If value of unit is correct (0 or 1), this function returns TRUE, otherwise FALSE.
<b>Usage</b>	WORD    tick=255; BYTE    unit=1; //unit is second. BOOL    bRet = SetWDT(tick, unit); //timeout value is 255 seconds

### StartWDT

<b>Syntax</b>	BOOL StartWDT(void);
<b>Description</b>	Starts WDT countdown. Once started, the WDT LED indicator will begin blinking. If ResetWDT() or StopWDT is not invoked before WDT countdowns to 0, the WDT expires and the system resets.
<b>Parameter</b>	None
<b>Return Value</b>	If the timeout value is given in correct format (WDT started), this function returns TRUE, otherwise FALSE
<b>Usage</b>	BOOL bRet = StartWDT();

### ResetWDT

<b>Syntax</b>	BOOL ResetWDT(void);
<b>Description</b>	Reset the timeout value to the value given by SetWDT().If ResetWDT() or StopWDT is not invoked before WDT countdowns to 0, the WDT expires and the system resets.
<b>Parameter</b>	None
<b>Return Value</b>	Always returns TRUE
<b>Usage</b>	BOOL bRet = ResetWDT();

### StopWDT

<b>Syntax</b>	BOOL StopWDT(void);
<b>Description</b>	Stops the countdown of WDT. When WDT has stopped, the WDT LED indicator stops blinking.
<b>Parameter</b>	None
<b>Return Value</b>	Always returns TRUE
<b>Usage</b>	BOOL bRet = StopWDT();

## Using DIO Function (With MezIO-R12 Installed)

### Wiring for DIO

The digital input function of System series is implemented using a photo-coupler with an internally series-connected 1kΩ resistor. You need to provide a voltage to specify the logic high/low state. The input voltage for logic high is 5~24V, and the input voltage for logic low is 0~1.5V.

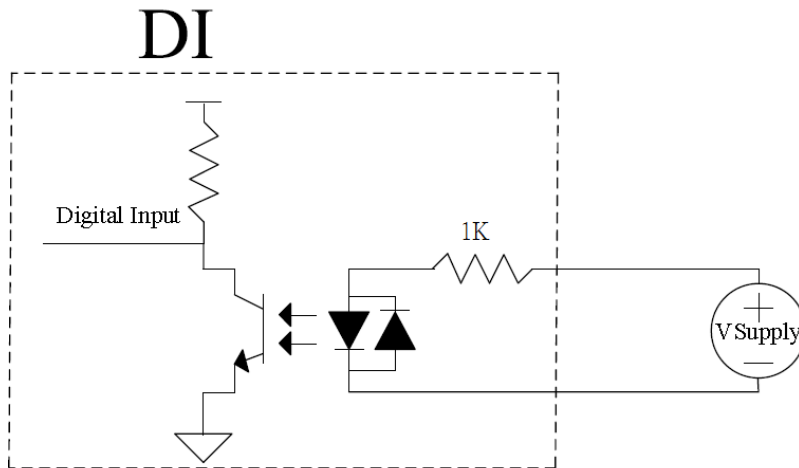

The digital output function of System series is implemented using Power MOSFET + Analog Device iCoupler® component. The DO channels are configured as NO (normally-open) configuration. When you turn on system, all DO channels have a deterministic state of logic 0 (circuit disconnected from GND return). When logic 1 is specified, MOSFET is activated and GND return path is established. The digital output function on System series supports sinking current connection. The following diagrams are the suggested wiring for DO:

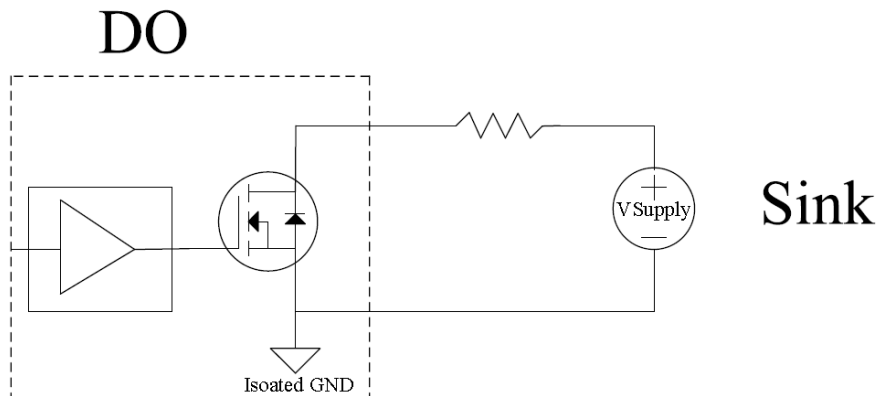



### DIO Pin Definition

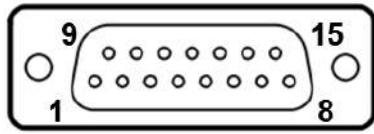

Pin#	Pin Definition	Pin#	Pin Definition
1	DI_0	9	DI_GND
2	DI_1	10	DI_2
3	DI_GND	11	DI_3
4	DO_GND	12	DO_GND
5	DO_0	13	DO_2
6	DO_1	14	DO_3
7	DO_GND	15	-
8	VDD		

## DIO Function Reference

### InitDIO

<b>Syntax</b>	BOOL InitDIO(void);
<b>Description:</b>	Initialize the DIO function. You should always invoke InitDIO() before write/read any DIO port/channel.
<b>Parameter</b>	None
<b>Return Value</b>	<b>TRUE:</b> Successfully initialized <b>FALSE:</b> Failed to initialize
<b>Usage</b>	BOOL    bRet = InitWDT();

### DIReadLine

<b>Syntax</b>	BOOL DIReadLine(BYTE ch);
<b>Description:</b>	Read a single channel of isolated digital input.
<b>Parameter</b>	<i>ch</i> BYTE value specifies the DI channel to be read. <i>ch</i> should be a value of 0 ~ 3.
<b>Return Value</b>	The status (TRUE or FALSE) of the specified DI channel.
<b>Usage</b>	BYTE    ch=3; //DI channel #3 BOOL    DIChValue = DIReadLine(ch); //read DI channel #3

### DIReadPort

<b>Syntax</b>	WORD DIReadPort(void);
<b>Description:</b>	Read the entire isolated digital input port (4 channels).
<b>Parameter</b>	None
<b>Return Value</b>	The status (TRUE or FALSE) of the specified DI channel.
<b>Usage</b>	WORD    DIPortValue = DIReadPort ();

### DOWriteLine

<b>Syntax</b>	void DOWriteLine(BYTE ch, BOOL value);
<b>Description:</b>	Write a single channel of isolated digital output.
<b>Parameter</b>	<p><i>ch</i>            BYTE value specifies the DO channel to be written.  <i>ch</i> should be a value of 0 ~ 3.</p> <p><i>value</i>            BOOL value (TRUE or FALSE) specifies the status of DO channel.</p>
<b>Return Value</b>	None
<b>Usage</b>	<pre>           BYTE    ch=3; //DI channel #3           BOOL    DOChValue=TRUE;           DOWriteLine(ch, DOChValue); //write DO channel #3 as           TRUE         </pre>

### DOWritePort

<b>Syntax</b>	void DOWritePort(WORD value);
<b>Description:</b>	Write the entire isolated digital output port (4 channels).
<b>Parameter</b>	<p><i>value</i>            WORD value specifies the status of the DO port.  <i>value</i> should be a value of 0~15.</p>
<b>Return Value</b>	None
<b>Usage</b>	<pre>           WORD    DOPortValue=0x0C; //1100b           DOWritePort(DOPortValue); //write DO port as 1100b         </pre>

### DOWriteLineChecked

<b>Syntax</b>	void DOWriteLineChecked(BYTE ch, BOOL value);
<b>Description:</b>	Write a single channel of isolated digital output and read-back the value of DO register. Note that this function is not returned until the DO register is checked and identical to the written value.
<b>Parameter</b>	<p><i>ch</i> BYTE value specifies the DO channel to be written. <i>ch</i> should be a value of 0 ~ 3.</p> <p><i>value</i> BOOL value (TRUE or FALSE) specifies the status of DO channel.</p>
<b>Return Value</b>	None
<b>Usage</b>	<pre> BYTE    ch=3; //DI channel #3 BOOL    DOChValue=TRUE; DOWriteLineChecked(ch, DOChValue); //write DO channel #3 as TRUE </pre>

### DOWritePortChecked

<b>Syntax</b>	void DOWritePortChecked(WORD value);
<b>Description:</b>	Write the entire isolated digital output port (8 channels) and check it has been done. Note that this function is not returned until the write value has been checked the same with the device registry.
<b>Parameter</b>	<p><i>value</i> WORD value specifies the status of the DO port. <i>value</i> should be a value of 0~15.</p>
<b>Return Value</b>	None
<b>Usage</b>	<pre> WORD    DOPortValue=0x0C; //1100b DOWritePortChecked(DOPortValue); //write DO port as 1100b </pre>

## COS Function Reference

### SetupDICOS

<b>Syntax</b>	<pre>BOOL SetupDICOS(COS_INT_SETUP *lpSetup, DWORD cbSetup);</pre>
<b>Description</b>	Setup Digital-Input(DI) Change-of-State(COS) interrupt parameters.
<b>Parameter</b>	<p><b><i>lpSetup</i> [in]</b>  A pointer to a <b>COS_INT_SETUP</b> structure that contains the COS configuration information for the DI device.  This data structure contains the following variables:</p> <p><b><i>portMask</i></b>  WORD value specifies the interrupt mask for corresponding channel(s).</p> <p><b><i>edgeMode</i></b>  WORD value specifies that interrupt is generated when level change (set to 0) or on rising/falling edge (set to 1) for the corresponding channel(s).</p> <p><b><i>edgeType</i></b>  WORD value specifies that interrupt is generated on rising edge (set to 0) or falling (set to 1) edge for corresponding channel(s). This value is neglected if <i>edgeMode</i> is set to 0 for the corresponding channel(s).</p> <p><b><i>cbSetup</i> [in]</b>  The length of the structure, in bytes. The caller must set this member to size of (COS_INT_SETUP).</p>
<b>Return Value</b>	<p><b>TRUE</b> if setup successes</p> <p><b>FALSE</b> if setup failed</p>
<b>Usage</b>	<pre>COS_INT_SETUP  setup; memset(&amp;setup, 0, sizeof(setup)); setup.portMask = 0x0f; // enable ch.0~3 setup.edgeMode = 0; // level setup.edgeType = 0x00; // Lo/Hi BOOL          bRet = SetupDICOS(&amp;setup, sizeof(setup));</pre>

### RegisterCallbackDICOS

<b>Syntax</b>	BOOL RegisterCallbackDICOS(COS_INT_CALLBACK callback);
<b>Description:</b>	Registers a callback function, which is called when the DICOS interrupt occurred.
<b>Parameter</b>	<p><b>callback [in]</b></p> <p>Specifies the callback function. The prototype for this function is described as follow.</p> <pre>void __stdcall callback_func(COS_INT_CALLBACK_ARG* arg);</pre>
<b>Return Value</b>	<p><b>TRUE</b> if setup successes,</p> <p><b>FALSE</b> if setup failed.</p>
<b>Usage</b>	<pre>void __stdcall callback_func(COS_INT_CALLBACK_ARG* arg) {     printf("data=0x%02x, flag=0x%02x, seq=%02d\n", arg-&gt;portData, arg-&gt;intrFlag, arg-&gt;intrSeq); } BOOL bRet = RegisterCallbackDICOS(callback_func);</pre>

### StartDICOS

<b>Syntax</b>	BOOL StartDICOS(void);
<b>Description</b>	Start DI Change-of-State interrupt
<b>Parameter</b>	None
<b>Return Value</b>	<p><b>TRUE</b> if start procedure successes</p> <p><b>FALSE</b> if start procedure failed</p>
<b>Usage</b>	BOOL bRet = StartDICOS();

## StopDICOS

<b>Syntax</b>	BOOL StopDICOS(void);
<b>Description</b>	Stop DI Change-of-State interrupt
<b>Parameter</b>	None
<b>Return Value</b>	<b>TRUE</b> if stop procedure successes <b>FALSE</b> if stop procedure failed
<b>Usage</b>	BOOL bRet = StopDICOS();

## DI COS Example

```
#include <stdio.h>
#include <stdlib.h>
#include <windows.h>
#include "WDT_DIO.h"

//Step 0, define a Change-of-State Interrupt callback function
void __stdcall callback_function(COS_INT_CALLBACK_ARG* arg)
{
    printf("data=0x%02x, flag=0x%02x, seq=%02d\n",
        arg->portData, arg->intrFlag, arg->intrSeq);
}

int main(int argc, char* argv[])
{
    //Step 1, initialize DIO library by invoking InitDIO()
    if ( ! InitDIO() )
    {
        printf("InitDIO --> FAILED\n");
        return -1;
    }
    printf("InitDIO --> PASSED\n");

    //Step 2, setup Change-of-State Interrupt mask and level/edge mode
    COS_INT_SETUP setup;
```

```
memset(&setup, 0, sizeof(setup));

setup.portMask = 0x0f;      // 00001111b, enable ch.0~3
setup.edgeMode = 0x00;     // generate interrupt on level change
setup.edgeType = 0x00;     // rising/falling edge, only effective when
edgeMode = 1

if ( ! SetupDICOS(&setup, sizeof(setup)) )
{
    printf("SetupDICOS --> FAILED\n");
    return -2;
}
printf("SetupDICOS --> PASSED\n");

//Step 3, register the callback function
if ( ! RegisterCallbackDICOS(callback_function) )
{
    printf("RegisterCallbackDICOS --> FAILED\n");
    return -3;
}
printf("RegisterCallbackDICOS --> PASSED\n");

//Step 4, start the DI Change-of-State Interrupt
if ( ! StartDICOS() )
{
    printf("StartDICOS --> FAILED\n");
    return -4;
}
printf("StartDICOS --> PASSED\n");

printf("\npress any key to stop...\n");
system("pause >nul");

//Step 5, stop the DI Change-of-State Interrupt operation
if ( ! StopDICOS() )
{
    printf("StopDICOS --> FAILED\n");
    return -5;
}
```



```
}  
printf("StopDICOS --> PASSED\n");  
  
printf("\npress any key to exit...\n");  
system("pause >nul");  
return 0;  
}
```

# Appendix B PoE On/ Off Control

The POC-410 system offers two 802.3at PoE+ ports with a unique feature to allow users manually turn on or off the power supply of each PoE port. This can be function can be useful in power device (PD) fault-recovery or power reset.

The function APIs are encapsulated in Neousys WDT\_DIO driver package. Please follow the instructions in [Appendix A Watchdog Timer & Isolated DIO](#) to install the driver package prior to programming PoE on/off control function

## PoE On/ Off Control Function Reference

### GetStatusPoEPort

<b>Syntax</b>	BYTE GetStatusPoEPort (Byte port);
<b>Description</b>	Get current on/off status of designated PoE port.
<b>Parameter</b>	<i>port</i>  BYTE value specifies the index of PoE port. Please refer to the following illustration, <i>port</i> should be a value of 1 ~ 2.
<b>Return Value</b>	BYTE value indicating PoE on/off status  0 if port is disabled (off)  1 if port is enabled (on)
<b>Usage</b>	BYTE bEnabled = GetStatusPoEPort (1); //Get on/off status of PoE Port#1

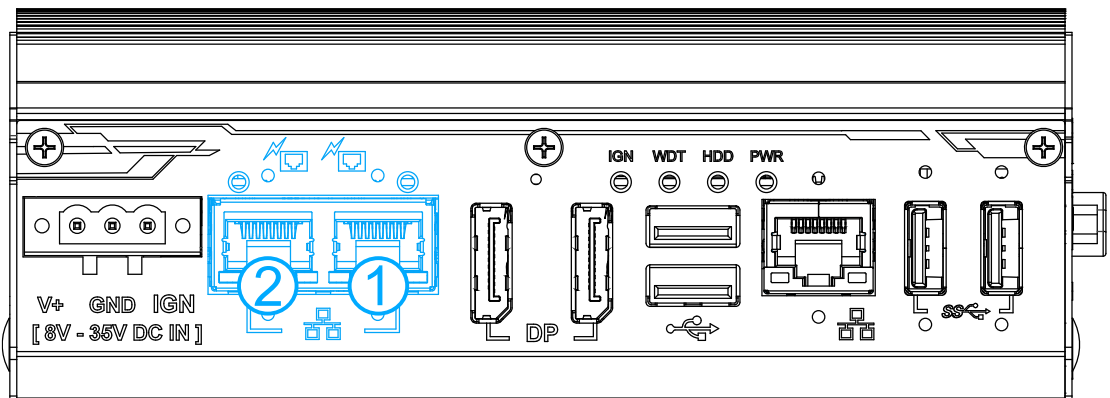

### EnablePoEPort

<b>Syntax</b>	BOOL EnablePoEPort (BYTE port);
<b>Description</b>	Turn on PoE power of designated PoE port.
<b>Parameter</b>	<i>port</i>  BYTE value specifies the index of PoE port. Please refer to the following illustration, <i>port</i> should be a value of 1 ~ 2
<b>Return Value</b>	<b>TRUE</b> if enabled success  <b>FALSE</b> if fail to enable.
<b>Usage</b>	BOOL bRet = EnablePoEPort (1); //Turn on PoE Port#1

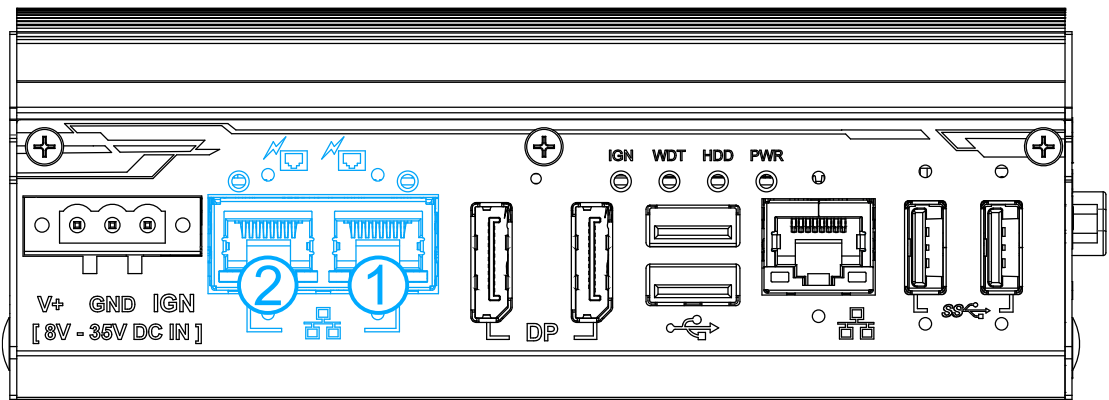

### DisablePoEPort

<b>Syntax</b>	BOOL DisablePoEPort (BYTE port);
<b>Description</b>	Turn off PoE power of designated PoE port
<b>Parameter</b>	<i>port</i>  BYTE value specifies the index of PoE port. Please refer to the following illustration, <i>port</i> should be a value of 1 ~ 2
<b>Return Value</b>	<b>TRUE</b> if disabled success  <b>FALSE</b> if fail to disable
<b>Usage</b>	BOOL bRet = DisablePoEPort (1); //Turn off PoE Port#1

